

9011

FINISHES:

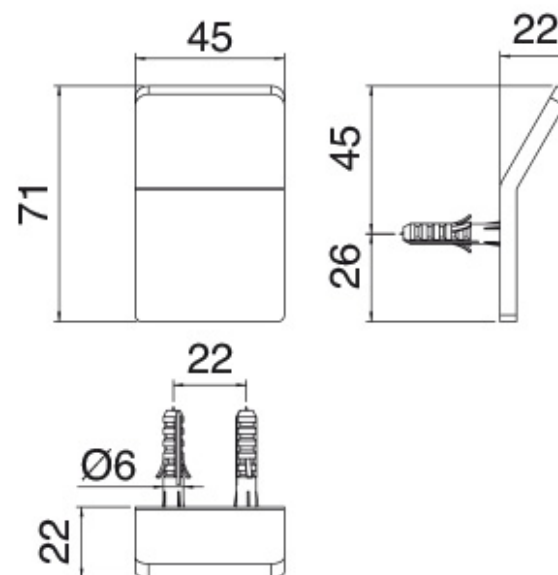

FROSTED INOX



RUBINETTERIE
tremme
instruments for water