

Or

Catalogo prodotti
Products catalogue
Produktkatalog

GSI[®]

ceramic
elements
italian
made.

Gran parte del progresso sta nella volontà di progredire.
Much of progress lies in the will to progress.
Fortschritt besteht wesentlich darin, fortschreiten zu wollen.

Seneca

Italian Made

I prodotti presenti in questo volume sono progettati e realizzati in Italia secondo i più alti standard qualitativi, nella tutela dell'ambiente, dei diritti e della salute dei lavoratori.

The products in this catalog are designed and produced in Italy according to the highest quality standards, the environmental protection and of course according to the rights and health of employees.

Die Produkte in diesem Katalog wurden in Italien unter Achtung der höchsten Qualitätsanforderungen, des Umweltschutzes und selbstverständlich der Rechte und der Gesundheit der Mitarbeiter entworfen und hergestellt.

Introduzione Introduction Einleitung	1	Sand	39	Norm	67	Kube	85
Azienda Company Unternehmen	4	Introduzione Introduction Einleitung	42	Introduzione Introduction Einleitung	70	Introduzione Introduction Einleitung	88
Produzione Manufacturing Herstellung	8	Abaco Products index Produktverzeichnis	40	Abaco Products index Produktverzeichnis	68	Abaco Products index Produktverzeichnis	86
Qualità senza compromessi Quality without compromises Qualität ohne Kompromisse	12	Disegni tecnici Technical drawings Technische Zeichnungen	173	Disegni tecnici Technical drawings Technische Zeichnungen	183	Disegni tecnici Technical drawings Technische Zeichnungen	193
Swirlflush	14						
Extraglaze	16						
Save water	18	Pura	109	Modo	133	Classic	145
Quick release	20						
Softclose	21						
Dual White	22						
Nel mondo In the world Weltweit	24	Introduzione Introduction Einleitung	112	Introduzione Introduction Einleitung	136	Introduzione Introduction Einleitung	148
Mercati Markets Märkte	25	Abaco Products index Produktverzeichnis	110	Abaco Products index Produktverzeichnis	134	Abaco Products index Produktverzeichnis	146
		Disegni tecnici Technical drawings Technische Zeichnungen	203	Disegni tecnici Technical drawings Technische Zeichnungen	215	Disegni tecnici Technical drawings Technische Zeichnungen	221
		Community	161				
		Introduzione Introduction Einleitung	164				
		Abaco Products index Produktverzeichnis	162				
		Disegni tecnici Technical drawings Technische Zeichnungen	229				



GSI ceramica è uno dei principali leader nel settore ceramico italiano e internazionale, azienda innovativa e punto di riferimento per il settore dell'arredobagno. La sua attività risale alle origini della tradizione produttiva del distretto ceramico di Civita Castellana, che ha saputo nel tempo far fronte alle sfide del mercato. In questo contesto i fondatori di GSI ceramica hanno modellato in maniera sapiente la tradizione artigianale insieme con la prorompente innovazione tecnologica in un processo di ricerca e rinnovamento continui, fondati su di un'etica del lavoro ed un sistema di valori che pone al centro dell'attenzione la dimensione umana, ed il saper fare tipico della produttività italiana. Così il rapporto fruttuoso tra imprenditore, progettista, operaio e management ha innescato un circolo virtuoso che consente di offrire prodotti dall'elevato standard qualitativo, secondo quello che è diventato il credo di GSI ceramica, "Italian Made". Soprattutto a partire dagli anni Novanta l'azienda riceve la spinta più forte verso l'innovazione, sotto la guida di un rinnovato management, giovane e preparato, che crede fortemente nel piano di sviluppo avviato, e che sta portando avanti una politica di crescita che vedrà ancora, nel prossimo futuro, GSI ceramica protagonista e interprete del buon Made in Italy.

GSI has always been one of the leader company in Civita Castellana's ceramics industry tradition. Since the 30's GSI has been using its entrepreneurial spirit to overcome market difficulties. In this context the founders of the company have cleverly modelled traditional craftsmanship with evolving technical innovations in a Research and Development process based on a work ethic and value system which focuses on the human insight and know-how typical of Italian industry. In this way there is a productive relationship between investors, management, designers and workers which has led to a virtuous circle enabling us to offer products with a clean designs and high standards of quality, following what has become GSI's byword, "Italian Made". The 90's are those characterized by a greater push towards innovation in a process of transformation that will bring the company to a total refurbishment obtained with considerable investment and aimed at increasing the human capital and technological-productivity. Aiming at obtaining tangible results in terms of innovation is the focus of GSI today thanks to a renewed management team that strongly believes in the new development plan. In a historic moment like today, where caution seems the only way forward, GSI ceramics continues its policy of growth building a bridge to an upcoming future that will see the company as a real protagonist and interpreter of good Made in Italy.

GSI gehört seit jeher zu den führenden Unternehmen in der traditionellen Keramikindustrie von Civita Castellana. Seit den 30er Jahren zeigt GSI Unternehmertegeist und überwindet damit die Schwierigkeiten auf dem Keramikmarkt. In diesem Zusammenhang haben die Unternehmensgründer in kontinuierlicher Forschung und Entwicklung handwerkliche Traditionen mit technischen Innovationen miteinander verbunden. Sie stützen sich dabei auf eine Arbeitsethik und ein Wertesystem, dass die Bedürfnisse des Menschen und das Geschick der italienischen Industrie in den Mittelpunkt stellt. Auf diese Weise entsteht ein produktives Zusammenwirken der Investoren, der Unternehmensleitung, der Designer und der Mitarbeiter und unser gemeinsames Ergebnis sind Produkte mit klarem Design und hohen Qualitätsmaßstäben, die sich im Leitsatz "Italian Made", von GSI manifestieren. Insbesondere in den 90ern wurde ein deutlicher Veränderungsprozess in Richtung Innovation angestoßen, innerhalb dessen das Unternehmen durch beträchtliche Investitionen in sowohl Humanressourcen als auch in technologische Produktivität komplett neu gestaltet wurde. Heute liegt der Fokus von GSI darauf, greifbare Ergebnisse in Sachen Innovation zu erzielen, nicht zuletzt mithilfe des neuen Managementteams, das überzeugt hinter dem jüngsten Entwicklungsplan steht. Mit dieser Wachstumspolitik möchte GSI ceramica auch eine Brücke in die Zukunft schlagen und das Unternehmen als Protagonist und Darsteller des guten "Made in Italy" präsentieren.



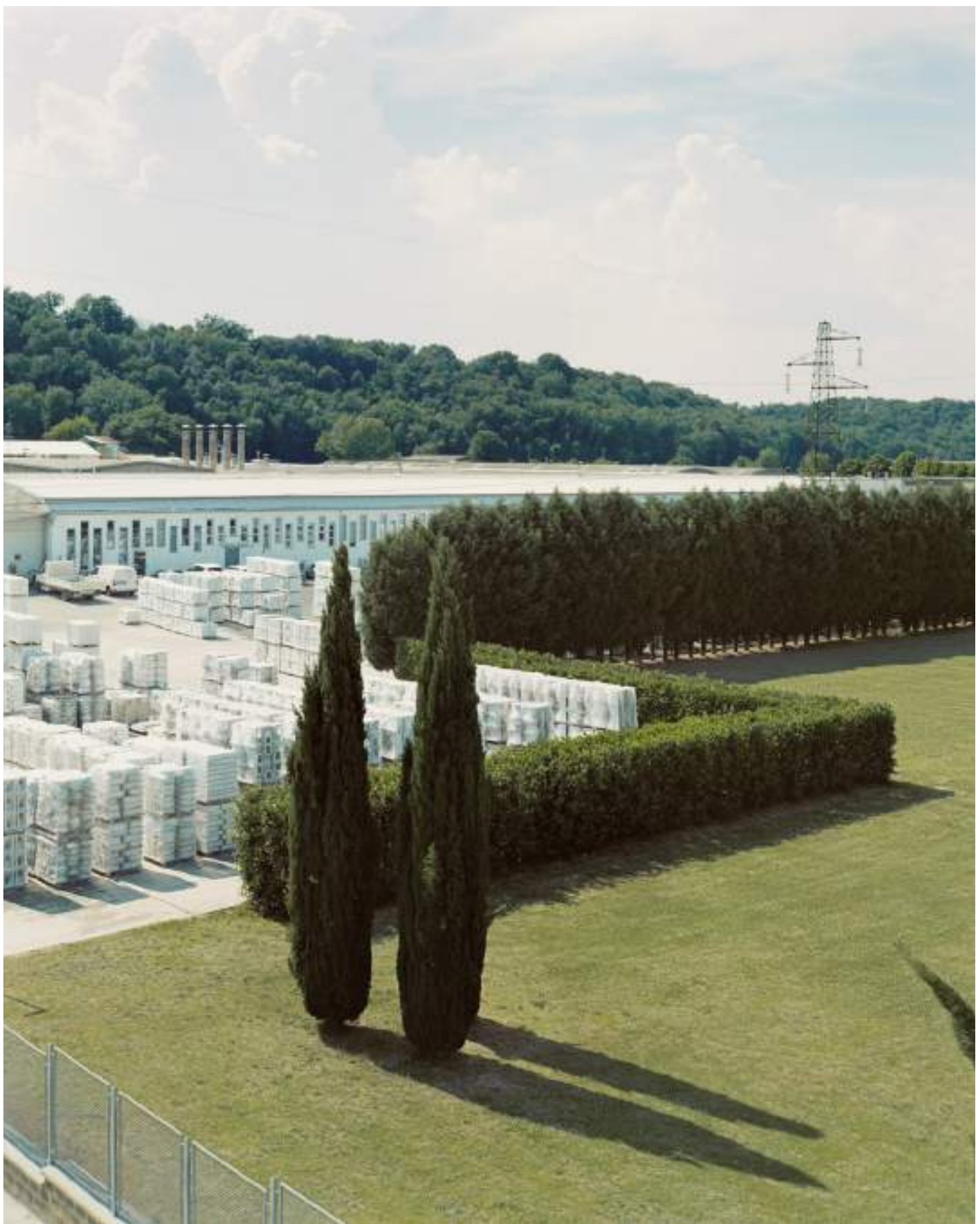



Manualità e automazione, artigianalità e tecnologia. I prodotti GSI ceramica sono il risultato di un complesso processo di sviluppo che impiega elevati livelli di tecnologia in ogni sua fase, dalla progettazione computerizzata in 3D alla prototipazione, all'innovativo sistema produttivo in alta pressione, alla smaltatura automatizzata ed al sistema di cottura a 1250°C sempre sotto il severo controllo del personale qualificato addetto alle operazioni di test e verifica. Ogni fase produttiva, ogni singolo articolo vengono testati per rispondere ad un rigido sistema di controllo nel rispetto delle più recenti normative europee di settore. Requisiti tecnici, funzionali ed estetici configurano un sistema di selezione dei prodotti che consente a GSI ceramica di offrire alla sua clientela solo i prodotti qualitativamente migliori dotati di documenti di certificazione CE. Negli ultimi anni l'azienda ha arricchito la sua dotazione produttiva installando impianti di colaggio ad alta pressione, i più innovativi ed efficienti per il settore ceramico. Questa tecnologia, di ultima generazione, permette di monitorare e controllare ogni fase di lavorazione del ciclo produttivo innescando un processo che innalza notevolmente il livello qualitativo del prodotto finito.

Manual ability and automation, craftsmanship and technology. GSI products are the result of a complex development process which harnesses the latest 3D system technology in every phase of design and prototyping. This is followed by a high pressure production method, automated enamelling and setting in a kiln running at 1250°C. The entire process is supervised in detail by qualified staff who carry out constant quality checking. Each phase of production, and every item produced, is tested against a strict quality control system conforming to the latest European standards. Technical, functional and aesthetic requirements form a selected system of products which allow GSI ceramics to only offer its clientele products that are of high level quality endowed with the certified document CE. Over the last few years, the company has invested in the latest generation production plants; high pressure casting systems which are the most innovative and efficient in the sector. This latest technology, allows a quality improvement and also grants a strict supervision throughout the entire production phase, considerably raising the qualitative standards of the finished product.

Handwerkliches Können und Automatisierung, Kunstfertigkeit und Technologie. Die GSI-Produkte sind das Ergebnis eines vielschichtigen Entwicklungsverfahrens, das in jeder Phase des Entwurfs und der Entwicklung von Prototypen die neueste Technologie des 3D-Systems einsetzt. Es folgen ein Hochdruck-Herstellungsverfahren, eine automatisierte Glasur und das Brennen im Ofen bei 1250°. Der gesamte Prozess wird bis ins Detail von qualifizierten Mitarbeitern überwacht, die durchgängig Qualitätskontrollen durchführen. In jeder Herstellungsphase wird jeder produzierte Artikel entsprechend eines strengen Qualitätssicherungssystems unter Einhaltung der geltenden europäischen Richtlinien getestet. Die Auswahl der Produkte erfolgt nach technischen, funktionalen und ästhetischen Gesichtspunkten, so dass GSI seinen Kunden nur Produkte mit höchster Qualität bietet und mit einer Bescheinigung zur CE-Kennzeichnung versehen kann. Während der vergangenen Jahre hat das Unternehmen in die jüngste Generation von Herstellungsanlagen investiert, wie die Systeme des Hochdruckgusses, die derzeit die innovativsten und effizientesten auf dem Markt sind. Diese neueste Technologie führt zu einer weiteren Qualitätssteigerung durch die nun mögliche, genaue Überwachung während des gesamten Herstellungsprozesses, wodurch die Qualitätsmaßstäbe des Endprodukts deutlich erhöht werden.





Qualità senza compromessi
Quality without compromises
Qualität ohne Kompromisse

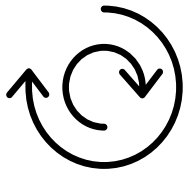
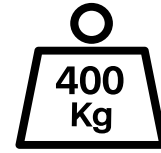

swirlflush®

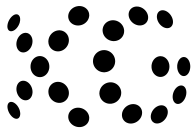
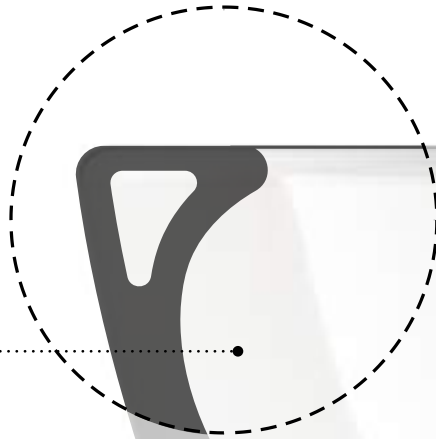

extraglaze®



<https://goo.gl/4vgkD1>

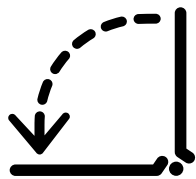

softclose

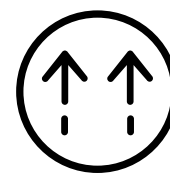

quickrelease



silent



save water

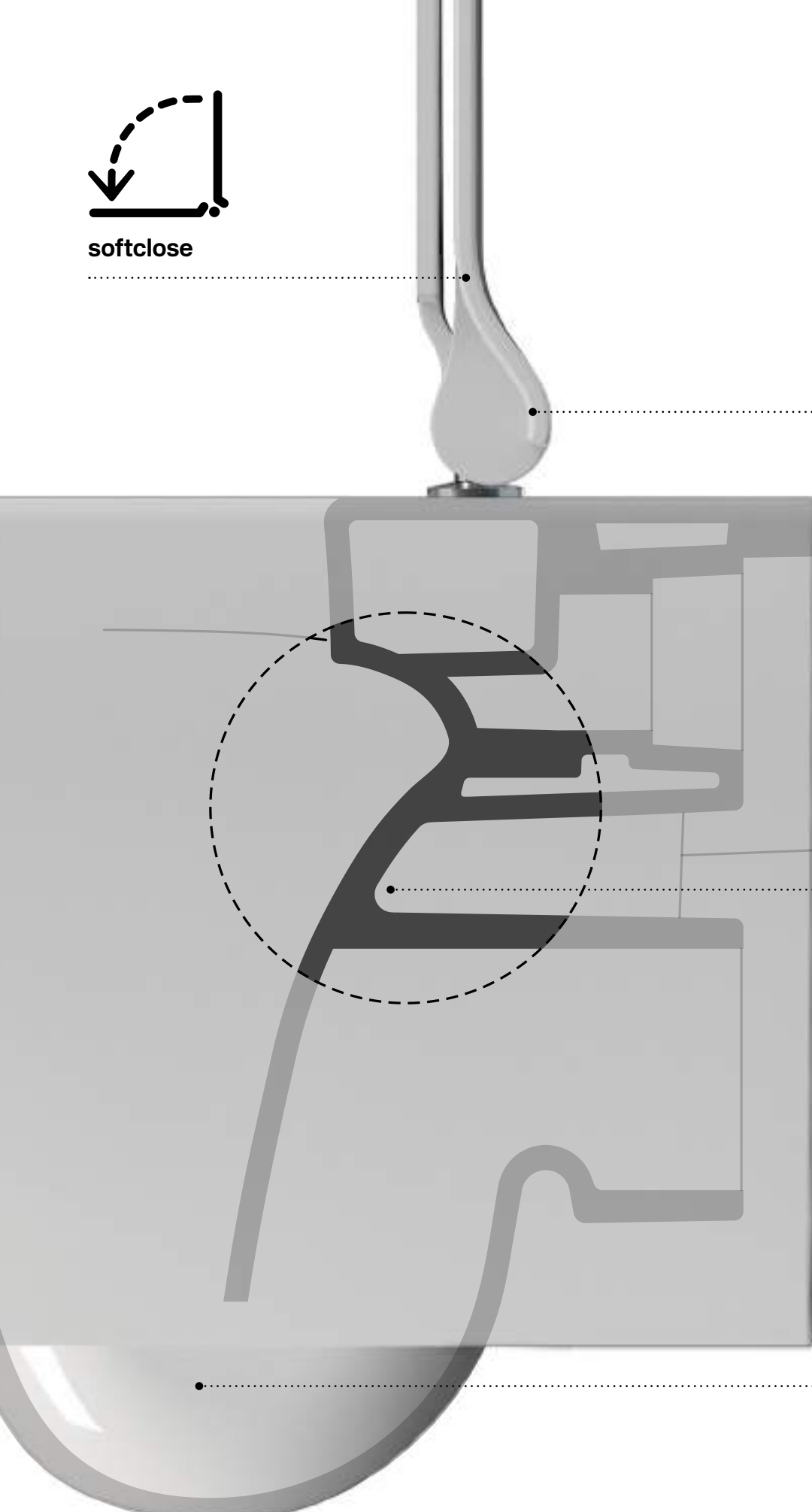

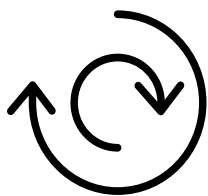

swirlflush®

Silenzioso, igienico, pulito.
Silent, hygienic, clean.
Still, hygienisch, sauber.

La costante volontà di migliorare le qualità dell'ambiente bagno, ha portato i tecnici di GSI a studiare e sviluppare il rivoluzionario sistema di scarico Swirlflush®. La caratteristica più evidente è l'assenza della tradizionale bordatura, la brida, all'interno della quale, in un normale wc, circola l'acqua al momento dello scarico. La particolare conformazione del sistema Swirlflush® direziona l'acqua sulle superfici ceramiche in maniera uniforme, assicurando una pulizia ottimale, migliorando le performance di scarico e riducendo al minimo il rumore. Il design Swirlflush®, non presentando parti nascoste o difficili da raggiungere, facilita inoltre le normali operazioni di pulizia del sanitario. Questo, combinato al rivestimento ceramico Extraglaze®, che rende le superfici estremamente levigate e lisce, garantisce un'igiene ottimale con il minimo sforzo.

With a constant desire to enhance the quality of the bathroom, GSI engineers have studied and developed the revolutionary Swirlflush® flushing system. The most evident characteristic is the absence of the traditional edge, the rim, inside which, in a standard WC, water circulates when flushing. The special shape of the Swirlflush® system steers flush water evenly on ceramic surfaces, ensuring perfect cleansing and better draining, and minimising noise. The Swirlflush® design has no hidden or difficult to reach parts, and thus routine cleaning operations are made easier. This, combined with the Extraglaze® coating, makes surfaces extremely smooth, ensuring perfect hygiene with the minimum effort.

Das konstante Streben nach Verbesserung der Badezimmerqualität hat die Techniker von GSI dazu veranlasst, das revolutionäre Spülsystem Swirlflush® zu entwickeln. Dessen Hauptmerkmal besteht im Fehlen des traditionellen Spülrandes, durch den bei einem normalen WC das Wasser beim Spülen geleitet wird. Die besondere Gestaltung des Swirlflush® Systems richtet das Wasser gleichmäßig auf die Keramikoberflächen und sichert dadurch optimale Sauberkeit bei zugleich verbesserter Spüleistung und geringerer Geräuschentwicklung. Da das Design von Swirlflush® keine verborgenen oder schwer erreichbaren Teile beinhaltet, werden ferner die normalen Reinigungsvorgänge des WCs erleichtert. Dies garantiert in Kombination mit der Keramikbeschichtung Extraglaze®, die für extrem polierte und glatte Oberflächen sorgt, optimale Hygiene bei minimalem Einsatz.



Il nuovo sistema di risciacquo SwirlFlush®, con una rumorosità di soli 64db, garantisce estrema silenziosità durante la fase di scarico.
Swirlflush® new flushing system with a noise level of just 64dB, is extremely quiet during the flushing performance.
Das neue Spülsystem, hat einen Geräuschpegel von nur 64 dB und garantiert damit extrem leises Spülen.

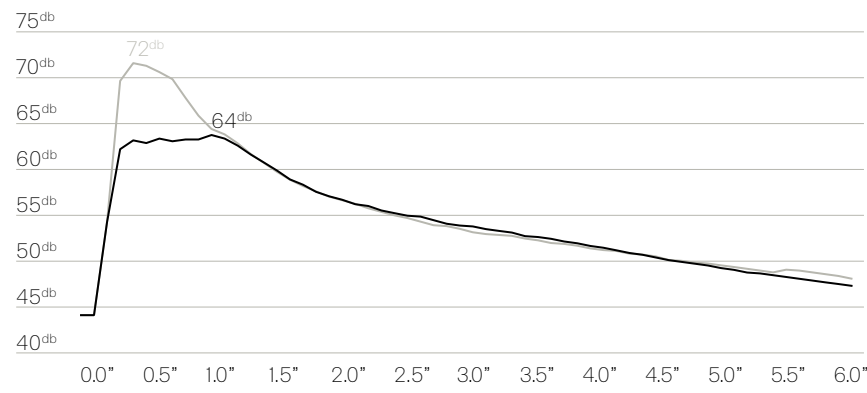

Standard WC
SwirlFlush®



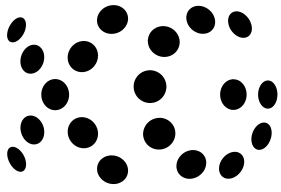

Extraglaze® è un nuovo smalto ceramico che, riducendo al minimo la formazione di pori superficiali, rende le superfici ceramiche più levigate, brillanti e facilmente lavabili. Extraglaze® viene applicato ai prodotti durante il ciclo di produzione e prima della loro cottura. In questo modo il nuovo smalto è parte integrante della ceramica ed i suoi effetti permanenti. I prodotti trattati con Extraglaze® sono più resistenti agli agenti chimici, e grazie all'estrema levigatezza e brillantezza, sono protetti da calcare e batteri e rimangono pulite più a lungo.

Extraglaze® is a new ceramic glaze which by minimizing the formation of surface pores, makes the ceramic surfaces smoother, brighter and easily washable.

Extraglaze® is applied to the products during the production cycle and prior to their firing. In this way, the new enamel is an integral part of the ceramic and its permanent effects.

The products treated with the ExtraGlaze® are more resistant to chemicals, and thanks to the extreme smoothness and brightness, they are protected from bacteria and limestone and stay clean longer.

Bei Extraglaze® handelt es sich um eine Keramikglasur, die die Bildung von Oberflächenporen reduziert und somit die Keramikoberflächen glatter, glänzender und pflegeleichter macht.

Extraglaze® wird auf die Produkte während der Herstellung und vor dem Brennen aufgetragen. Auf diese Weise ist die Glasur ein Bestandteil der Keramik und dauerhaft wirksam.

Die mit Extraglaze® behandelten Produkte sind resistenter gegen Chemikalien und dank der glatten und glänzenden Oberfläche sind sie besser vor Bakterien und Kalkstein geschützt und bleiben länger.

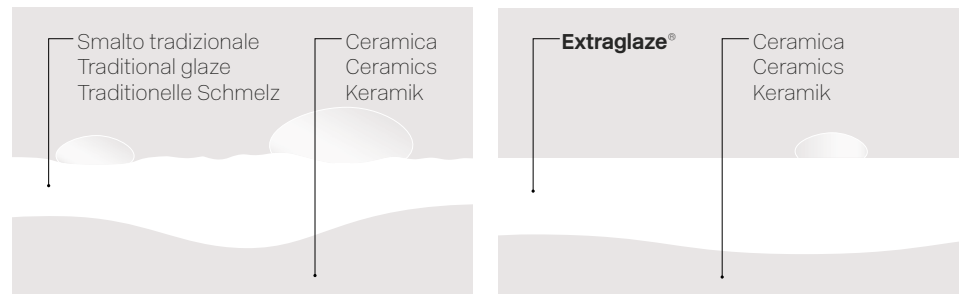



Qualità: superfici ceramiche tecnicamente avanzate, resistenti agli agenti chimici, levigate e brillanti, mantengono queste caratteristiche inalterate nel tempo.

Quality: technically advanced ceramic surfaces, chemical-resistant, smooth and shiny, which keep these characteristics unchanged in time.

Qualität: technisch fortschrittliche, chemikalienfeste, polierte und glänzende Keramikoberflächen, die diese Eigenschaften unverändert auf lange Zeit bewahren.



Efficienza: grazie all'estrema planarità delle superfici, l'acqua scivola molto più facilmente migliorando notevolmente le operazioni di risciacquo e scarico.

Efficiency: thanks to the extreme flatness of the surfaces, the water flows much easier, dramatically improving the rinsing and flushing operations.

Effizienz: dank der extremen Ebenheit der Oberflächen rinnt das Wasser sehr viel leichter ab, wodurch die Spül- und Abflussvorgänge erheblich verbessert werden.



Igiene: l'estrema planarità micrometrica delle superfici riduce enormemente l'accumulo di sporco e calcare, garantendo di conseguenza una pulizia e un'igiene ottimali.

Hygiene: the extreme micrometric flatness of the surfaces enormously reduces the accumulation of dirt and limestone, thereby ensuring an optimal cleaning and hygiene. **Hygiene:** die extreme mikrometrische Ebenheit der Oberflächen reduziert das Entstehen von Schmutz- und Kalkablagerungen stark, wodurch optimale Sauberkeit und Hygiene garantiert werden.



Sostenibilità: Extraglaze® consente un minor consumo di acqua e detersivi per le comuni operazioni di pulizia.

Sustainability: Extraglaze® allows a minor use of water and detergents during common cleaning. **Nachhaltigkeit:** Extraglaze® sorgt für verringerten Verbrauch an Wasser und Reinigungsmitteln für die gewöhnlichen Reinigungsvorgänge.



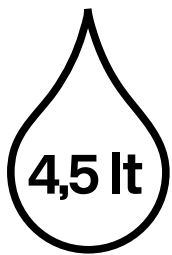

save water

L'acqua è un diritto, sprecarla è un delitto
Water is a right, wasting it is a crime
Wasser ist ein Recht,
Wasserverschwendung ist eine Straftat.

Con la volontà di preservare il bene più prezioso che ci appartiene, GSI progetta tutti i sanitari integrando lo speciale sistema di scarico "Save Water". Il sistema, creato dall'ufficio stile GSI ceramica, è frutto di un continuo lavoro di sviluppo e perfezionamento tecnico, ed è ottenuto grazie alla particolare conformazione delle parti ceramiche a contatto con l'acqua. Il sistema "Save Water" consente di eseguire le funzioni di scarico con soli 4,5 lt di acqua. Nel presente catalogo il logo "Save Water" individua i wc che sono dotati dell'efficiente sistema di scarico a 4,5 lt.

Aiming to preserve the most valuable asset that we have, GSI designs all its sanitary ware with the special flush system "Save Water". The system, created by the GSI design team, is the result of continuous technical development and is achieved thanks to the special shape of the ceramic parts directly in contact with water. The "Save Water" system allows you to flush with just 4,5 litres of water. In this catalogue the logo "Save Water" identifies toilets that have this system implemented.

Zum Schutz der wertvollsten Ressource des Menschen stattet GSI die gesamte Sanitärkeramik mit dem besonderen Spülsystem "Save Water" aus. Das vom GSI-Designerteam entworfene System ist das Ergebnis einer kontinuierlichen technischen Entwicklung und beruht auf der besonderen Form der Keramikteile, die in direktem Kontakt mit dem Wasser sind. Dank des "Save Water"-Systems werden beim Spülen nur 4,5 Liter verbraucht. In diesem Katalog sind die Toiletten mit diesem System mit dem Logo "Save Water" gekennzeichnet.

9

i litri di acqua
generalmente utilizzati
liters of water generally used
allgemein verbrauchte
Liter Wasser



6

i litri di acqua richiesti
dalle normative europee
liters of water required
by European standards
von den europäischen Richtlinien
vorgeschriebene Liter Wasser



4,5

i litri di acqua utilizzati
da un wc GSI
liters of water used
by a GSI wc
von einem GSI-WC
verbrauchte Liter Wasser





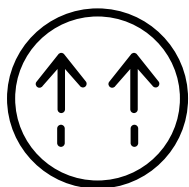

quickrelease



GSI ceramica introduce un nuovo copriwater con un innovativo sistema di installazione. Il nuovo sistema "Quick Release" si contraddistingue per la facilità con cui permette di estrarre il copriwater in maniera semplice e senza l'impiego di utensili di alcun genere. È sufficiente tirare il copriwater verso l'alto esercitando una forza sufficiente alla sua estrazione. In questo modo sarà possibile eseguire le operazioni di pulizia del copriwater e del wc anche nelle superfici generalmente difficili da raggiungere garantendo una maggiore igiene. Altrettanto semplice sarà il riposizionamento del copriwater: una volta posizionato in corrispondenza delle cerniere sarà sufficiente esercitare una pressione relativamente debole. In abbinamento al sistema di chiusura soft-close i copriwater GSI raggiungono livelli di efficienza e comfort senza precedenti. Il sistema soft-close predispone il copriwater per una chiusura rallentata. Questo consentirà di evitare cadute accidentali e chiusure del copriwater troppo violente garantendo comfort ed evitando danni accidentali.

GSI ceramica introduces a new seat & cover with an innovative installation system. The new "Quick Release" system is distinguished by the simplicity with which it allows to pull out the seat & cover in a simple way and without the use of any kind of tool. Simply pull the seat and cover up using a sufficient force for its removal. This will make it possible to clean the toilet seat and even the wc in areas that are usually difficult to reach, granting a major hygiene. Repositioning the seat & cover is as simple; once placed on the hinges, it will be sufficient to employ a relatively weak pressure. Matching up with the soft-close system, the GSI seat and covers reach levels of efficiency and comfort never reached before. The soft-close system predisposes the seat and cover for a slow closing. This will prevent accidental falls and violent closures of the seat and cover, preventing damages.

GSI ceramica führt einen neuen WC-Sitz mit einem innovativen Installationssystem ein. Das neue „Quick Release“ System unterscheidet sich von anderen durch die Einfachheit, mit der der WC-Sitz ohne den Einsatz von Werkzeugen abgenommen werden kann. Einfach den WC-Sitz mit ausreichend Kraft zum Hochheben entfernen. So kann der WC-Sitz und das WC auch an Stellen gereinigt werden, die normalerweise schwierig zu erreichen sind, und die Hygiene ist verbessert. Das Zurücksetzen des WC-Sitzes ist genauso leicht: einfach auf die Scharniere platzieren und mit leichtem Druck einsetzen. In Verbindung mit dem Soft Close-Mechanismus ist der WC-Sitz so funktionsfähig und bequem wie nie zuvor. Der Soft Close-Mechanismus sorgt dafür, dass der WC-Sitz langsam schließt. Dadurch wird verhindert, dass der Sitz versehentlich oder zu heftig auf die Brille fällt und diese beschädigt werden.



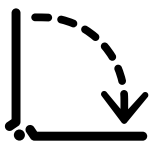

dual white



Con Dual White, GSI coniuga igiene ed eleganza conferendo un tratto originale e distintivo ai propri sanitari. La tecnologia Dual White, che combina la smaltatura opaca alla lucida, è la novità indirizzata ad una clientela attenta ai particolari e alle innovazioni sul mercato. La purezza della finitura opaca incontra, nelle parti idrauliche a contatto con l'acqua, la smaltatura Extraglaze®, evitando macchie ed antigienici residui calcarei, frequenti conseguenze della tipica porosità del prodotto in ceramica con un'unica finitura opaca. Al contrario, la levigatezza delle superfici ceramiche smaltate con Extraglaze® diminuisce l'attrito che l'acqua incontra durante la fase di scarico del wc, migliorandone le performance e riducendo sensibilmente il consumo di acqua. Oltre a ciò, il connubio Extraglaze®/Swirlflush® arricchisce ulteriormente la dotazione del wc: efficienza dello scarico, silenziosità, maggior igiene e pulizia derivante dall'assenza della brida. Setosa, materica, sofisticata e di tendenza, la finitura Dual White esalta alla perfezione le morbide linee della collezione Pura.

GSI has combined hygiene and elegance in its Dual White range, giving sanitaryware an original and distinctive touch. Dual White technology combines gloss and matt glazes in a range of products aimed at customers with an eye for detail and for innovation.

Where parts come into contact with water, the purity of the matt finish meets our Extraglaze® enamel, designed to prevent unhygienic lime deposits, a frequent phenomenon due to the porous nature of ceramic products having a single matt finish. The smoothness of ceramic surfaces coated with Extraglaze® enamel reduces the friction encountered by water when the WC is flushed, enhancing its performance and significantly reducing water consumption. The Extraglaze®/Swirlflush® double act further enhances the WC: efficient, quiet flushing, greater hygiene and cleanliness due to the rimless bowl. Silky, tactile, sophisticated and stylish, the Dual White finish is a perfect ally for the soft lines of the Pura collection.

Bei Dual White kombiniert GSI Hygiene mit Eleganz und verleiht dadurch den Sanitärobjekten einen unterscheidenden Zug. Die Dual-White-Technologie, bei der Matt- und Glanzglasur miteinander verbunden werden, stellt die Neuheit dar, die sich an Kunden mit einem besonderen Augenmerk für innovative Details wendet.

Die Reinheit der matten Oberflächen trifft bei den im Kontakt mit Wasser stehenden Teilen auf die Glasur Extraglaze®, dank der Fleckenbildung und unhygienische Kalkablagerungen verhindert werden, die oftmals Folge jener typischen Porosität von Keramikprodukten mit einheitlich matt glasierter Oberfläche sind. Im Gegensatz dazu verringert die Glätte der mit Extraglaze® glasierten Keramikflächen die Reibung, auf die das Wasser in der Spülphase des WCs stößt, wodurch die Leistung verbessert und der Wasserverbrauch reduziert wird. Zusätzlich bereichert die Kombination Extraglaze®/Swirlflush® die Ausstattung des WCs weiter: effiziente und zugleich leise Spülung, verbesserte Hygiene und Sauberkeit dank des fehlenden Spülrands. Seidig, stofflich, raffiniert und tendenzweisend: Dual White hebt die Perfektion und die sanften Linien der Kollektion Pura hervor.



Nel mondo In the world Weltweit

Situata nel cuore del principale distretto ceramico in Italia per la produzione di sanitari, GSI trae dalla tradizione tutta la sua vitalità, il suo carattere dinamico ed il suo spirito intraprendente. Innovazione, design ed apertura verso l'esterno hanno consentito a GSI, nel corso del tempo, di intessere una rete di relazioni internazionali con clienti, partner commerciali, ed estimatori in senso più ampio che permette all'azienda di essere partecipe ed interprete del Made in Italy anche fuori dal mercato domestico con la partecipazione ad eventi, convegni e progetti per il contract come testimoniano il Tiara Chateau Hotel di Parigi, il Madinat Jumeirah di Dubai, il Vip Grand di Lisbona, il Yas Marina di Abu Dhabi e molti altri.

Located in the heart of Italy's primary ceramic sanitary ware production district, GSI draws its vitality, dynamism and enterprising spirit from this tradition. Innovation, design and being open to new trends has allowed GSI, over time, to weave a network of international relationships with clients, commercial partners and fans that allows the company to be a leading exponent of the Made in Italy brand outside the domestic market thanks to its presence at events, conferences and various projects such as the Tiara Chateau Hotel in Paris, Madinat Jumeirah in Dubai, Vip Grand Lisbon, Yas Marina in Abu Dhabi and many more.

GSI hat seinen Sitz im Herzen von Italiens größter Industriezone für Sanitärkeramik und zieht aus dieser Tradition seine Vitalität, seine Dynamik und seinen Unternehmergeist. Mit Innovation, Design und Aufgeschlossenheit gegenüber neuen Trends hat GSI im Laufe der Zeit ein Netzwerk internationaler Geschäftsbeziehungen mit Kunden, Handelspartnern und Bewunderern geschaffen und sich außerhalb des italienischen Markts dank der Teilnahme an Events, Konferenzen und verschiedener Projekte, wie dem Tiara Chateau Hotel in Paris, dem Madinat Jumeirah in Dubai, dem Vip Grand Lisboa Hotel und Yas Marina in Abu Dhabi, als führender Vertreter der Marke "Made in Italy" einen Namen gemacht.



Oltre che nel mercato domestico italiano, dove viene destinato il 53% del materiale prodotto, GSI ceramica è presente nei mercati internazionali dove colloca il 47% della sua produzione, in particolare nei paesi Europei, nei paesi emergenti dell'Est, nell'area Asiatica ed Araba fino alla Nuova Zelanda. Sostenuta dalla spinta della domanda di prodotti di qualità superiore, GSI ceramica prosegue nella sua politica di espansione nella fascia più evoluta dei diversi mercati.

Other than the national Italian market, where 53% of the produced material is destined, GSI is also present in the international markets where it sets 47% of its production, in particular in the European countries, the emerging countries of the East, in the Asiatic and Arab countries up-to New Zealand. Supported by the push of demand of products with high quality, GSI continues in its policy of expanding in the most evolved range of different markets.

Neben dem nationalen italienischen Markt, für den 53% der Produkte bestimmt sind, ist GSI auch mit 47% seiner Produktion auf den internationalen Märkten vertreten, darunter insbesondere die europäischen Länder, die aufstrebenden Länder im Osten, die asiatischen und arabischen Länder bis hin zu Neuseeland. Geflügelt von der starken Nachfrage nach hoch qualitativen Produkten setzt GSI seinen Wachstumstrend in den hoch entwickelten Bereichen verschiedener Märkte fort.

America: Bogotá, Philadelphia.

Asia: Abu Dhabi, Baku, Chennai, Delhi, Doha, Dubai, Hong Kong, Riyadh, Shanghai, Singapore, Tokyo.

Oceania: Auckland, Melbourne, Perth, Sydney.

Europe: Amsterdam, Athens, Belgrade, Bern, Cologne, Copenhagen, Düsseldorf, Frankfurt, Glasgow, Graz, Kiev, Larnaca, Lisbon, Ljubljana, London, Moscow, Munich, Nuremberg, Oslo, Porto, Prague, Riga, Rotterdam, Saint Petersburg, Salzburg, Sofia, Tirana, Valletta, Vilnius, Warsaw, Wien, Zagreb.



Lavabi

Washbasins

Waschbecken

Sand

125

9052111
125x50



70

9087111
70x40



60/TS

908311
60x38



120

9024111
120x50

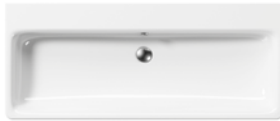

55

9086111
55x40



50/TS

908211
50x38



100

9023111
100x50

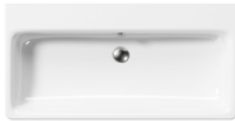

40

9084111
40x32



48/TS

903511
Ø48



100

9051111
100x50



42/TS

904811
Ø42



80

9022111
80x50



h85

905811
905911
55x38



70/TO

904111
70x42



60

9031111
60x50



60/TO

904911
60x42



50

9085111
50x50



42/TO

902811
Ø42



Norm

70/TE
 908911
 70x37



55/TE
 903011
 55x35



45/TE
 903411
 Ø45



35/TE
 905011
 Ø35



60/i
 903311
 60x45



125
 862511
 125x50



120
 862411
 120x50



100
 862311
 100x50



90
 868811
 90x50



75
 868711
 75x50



60
 868311
 60x50



42
 868411
 42x34



35
 865011
 35x26



h85
 7559011
 7558011
 56x40 h85



h85
 7557111
 7556111
 56x40 h85



Lavabi

Washbasins

Waschbecken

Kube

150

8963111

150x50



120

8952111

120x47



50

8986011

50x25



120

8924111

120x47

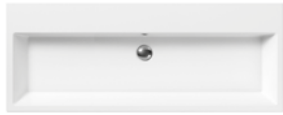

100

8951111

100x47



40

8984011

40x23



100

8923111

100x47

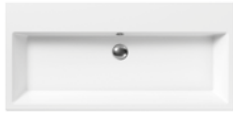

80/d

8956111

80x47



80

8922111

80x47



80/s

8957111

80x47



60

8931111

60x47



60/d

8938111

60x47



50

8930111

50x47



60/s

8939111

60x47



45

8985111

45x35



Pura

60/TS

8983011

60x38



50/TS

8982011

50x38



50/TI

894711

50x37



37/TI

895011

37x37



55/s

8934111

55x47



58/i

8933011

58x45



120

8824111

120x50



100

8823111

100x50



80

8822111

80x50



80/d

8856111

80x50



80/s

8857111

80x50



60

8831111

60x50



102

8825111

102x52



82

8826111

82x52



60/TI

883711

60x38



50/TI

884711

50x38



39/TI

884611

Ø39



38/TI

885011

38x38



Modo

Classic

60/TS

888311

60x38



120

7724111

120x50



125

8725111

125x54



50/TS

888211

50x38



100

7723111

100x50



105

8723111

105x54



48/TS

883511

Ø48



80

7722111

80x50



90

8788111

90x50



42/TS

882811

Ø42



65

7732111

65x50



75

8787111

75x50



50

7785111

50x40



60

8731111

60x46



55/U

724311

55x38



50/U

724711

50x35



Community

Incasso

60/T

874911

60x40



70

7631011

70x60



61/I

MASIAN111

61x52



57/I

MALISEON111

57x47



55/U

724311

55x38



50/U

724711

50x35



57/U

MVULCN11

57x42



Wc e Bidet

Wc and Bidet

Wc und Bidet

Sand

55

901211
9065111
54,5x37



55/F

901511
54,5x37



50

901811
9064111
50x37



50/F

901611
51x37



55

901411
9062111
54,5x37



Norm

55

861211
8665111
55x36



55/F

861511
55x36



50

861811
8664111
50x36



50/F

861611
50x36



45

861011
45x35



55

861411
8662111
55x36



68

861711
68x36



Kube

55

891211
8965111
55x36



55/F

891511
55x36



50

891811
8964111
50x36



50/F

891611
50x36



Pura

55

881211
8865111
55x36



55/F

881511
55x36



55/F

881111
8861111
54,5x35



50

881811
8864111
50x36



50/F

881611
50x36



55

881411
8862111
55x36



55/F

881011
55x36



50

881911
8869111
50x36



68

881711
68x38



Modo

55

771211
7765111
55x38



51

771011
7760111
51x38



Classic

55

871211
8765111
55x37



54

871011
871111
8762111
54x37



70

871711
70x37



Community

70

761811
70x37



Orinatoio

Urinal

Urinal

Pura

39

769711

39x31



36

889711

36x25



Community

39

769711

39x31



Vasca

Bathtub

Badewanne

Sand

185

VASAND90
185x90



180

VASAND80
180x80



Kube

179

VAT80
179x80



Pura

190

VAPR90
190x90



Modo

190

VAM95
190x95



Classic

175

VAL1
VAL2
175x82



Piatti doccia

Shower trays

Duschwannen

H6

140

358711

140x80



90/q

339711

90x90



120

359811

120x80



80/q

338611

80x80



120

359911

120x70



90

349711

90x90



100

358611

100x80



80

348611

80x80



100

358911

100x70



90

359711

90x72



H11

120

299411

120x80



90/q

439011

90x90



90

449011

90x90



120

299311

120x70



80/q

438011

80x80



80

448011

80x80



100

298811

100x80



75/q

437511

75x75



90/d

459611

90x70 dx



100

299111

100x72



70/q

437011

70x70



90/s

459511

90x70 sx



90

259011

90x72



85

458511

85x70



Sand

Lavabi

Washbasins

Waschbecken

Sand

125

9052111

125x50

**70**

9087111

70x40

**60/TS**

908311

60x38

**120**

9024111

120x50

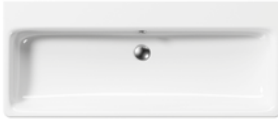
**55**

9086111

55x40

**50/TS**

908211

50x38

**100**

9023111

100x50

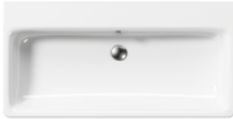
**40**

9084111

40x32

**48/TS**

903511

Ø48

**100**

9051111

100x50

**42/TS**

904811

Ø42

**80**

9022111

80x50

**h85**

905811

905911

55x38

**70/TO**

904111

70x42

**60**

9031111

60x50

**60/TO**

904911

60x42

**50**

9085111

50x50

**42/TO**

902811

Ø42



Wc e Bidet

Wc and Bidet

Wc und Bidet

Vasca

Bathtub

Badewanne

70/TE

908911

70x37



55/TE

903011

55x35



45/TE

903411

Ø45



35/TE

905011

Ø35



60/I

9033111

60x45



55

901211

9065111

54,5x37



55/F

901511

54,5x37



50

901811

9064111

50x37



50/F

901611

51x37



55

901411

9062111

54,5x37



185

VASAND90

185x90



180

VASAND80

180x80



Sand

Sand

Sand è una collezione di sanitari dal carattere distintivo. Il suo design è fondato sull'idea progettuale di creare prodotti affascinanti. Già nel nome si intuisce l'intento creativo che si materializza in prodotti dalle forme sinuose e morbide ad evocare quelle delle immense distese sabbiose che per contrasto richiamano alla mente il flusso dell'acqua che scorre nei catini avvolgenti dei lavabi e dei sanitari Sand.

Sand is a sanitary ware range characterized by unique features. Its design is based on the idea of creating attractive products. From its name it is easy to picture the inspiration that was transformed into the sinuous and soft shapes of the range: deserted sandy beaches and the flow of water in the enveloping shape of Sand basins and sanitary ware.

Sand ist eine Sanitärkeramik-Serie mit einzigartigen Merkmalen. Das Design beruht auf der Idee, attraktive Produkte zu schaffen. Schon vom Namen ist ganz einfach die Inspirationsquelle abzuleiten, die sich in den geschmeidigen und weichen Formen des Sortiments widerspiegelt: leere Sandstrände und der Wasserfluss eingebettet in den Formen der Sand Becken und Badkeramik.





Sand 125x50
Lavabo / Washbasin

Sand 55x37
Wc-Bidet

H6 140x80
Platto doccia / Shower tray





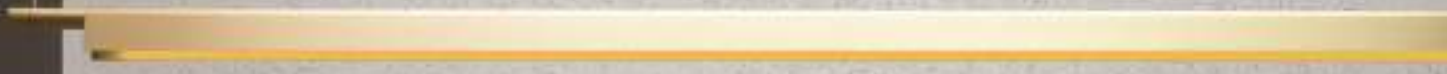



Sand 55x35
Lavabo / Washbasin









Sand 100x50
Lavabo / Washbasin

Sand 55x37
Wc-Bidet

Sand 185x90
Vasca/Bath tub

H6 120x80
Platto doccia / Shower tray



Sand 100x50
Lavabo / Washbasin















Sand Freestanding 55x38 h85
Lavabo / Washbasin

Sand 55x37
Wc-Bidet

Sand 180x80
Vasca/Bathtub





Sand 50x38
Lavabo / Washbasin





Sand 80x50
Lavabo / Washbasin







Norm

Lavabi

Washbasins

Waschbecken

Norm

h85

7559011

7558011

56x40 h85

**h85**

7557111

7556111

56x40 h85

**125**

8625111

125x50

**120**

8624111

120x50

**100**

8623111

100x50

**90**

8688111

90x50

**75**

8687111

75x50

**60**

8683111

60x50

**42**

8684111

42x34

**35**

8650111

35x26



Wc e Bidet

Wc and Bidet

Wc und Bidet

55**861211****8665111**

55x36

**55****861411****8662111**

55x36

**55/F****861511**

55x36

**50****861811****8664111**

50x36

**68****861711**

68x36

**50/F****861611**

50x36

**45****861011**

45x35



Norm

Norm è la proposta minimalista di GSI ceramica, una collezione destinata ad un pubblico dal gusto evoluto che apprezza la purezza delle forme, le linee semplici e regolari prive di orpelli o segni inutili. I rapporti dimensionali, le caratteristiche di funzionalità e la declinazione nelle varie misure suggeriscono l'idea di una famiglia di sanitari capace di soddisfare innumerevoli esigenze di spazio e di personalizzazione. Inoltre, la predisposizione per l'abbinamento con accessori e arredi, rende possibile la creazione di un ambiente bagno piacevole, elegante, funzionale, minimalista.

Norm is GSI's minimalist offering, for the client with taste who appreciates simplicity. It is a simple range with nothing superfluous, nothing ornamental. Its multiple dimensions and functionality comprise a sanitary range which can be customised to meet a wide range of spaces and requirements. Once combined with accessories and fixtures, this range creates a pleasing, functional elegant and minimal bathroom space.

GSI hat Norm für Minimalisten entworfen, für Kunden mit Geschmack, die die Einfachheit schätzen. Es ist eine schlichte Serie ohne Überflüssiges und ohne Schnörkel. Diese Sanitärkeramik ist in zahlreichen Maßen und Funktionen erhältlich und kann so auf den einzelnen Kunden und sein Platzangebot und seine individuellen Anforderungen zugeschnitten werden. Kombiniert mit Zubehör und Inventar schafft diese Serie eine angenehme, funktionale, elegante und schlichte Badezimmerumgebung.







Norm 125x50
Lavabo / Washbasin



Norm 55x36
Wc-Bidet



HG 140x80
Piatto doccia / Shower tray





Norm 55x36
Wc-Bidet



Norm Element Free 56X40 185
Lavabo / Washbasin

Norm 55X36
WC-Bidet



Norm 55x36
Wc Swirflush





Norm 55x36
Wc Swirlflush



Norm 120x50
Lavabo / Washbasin

Norm 68x36
Monoblocco / Close Coupled

Norm 55x36
Bidet





Norm 120x50
Lavabo / Washbasin





Lavabi

Washbasins

Waschbecken

Kube

150**8963111**

150x50

p.75

**120****8952111**

120x47

p.75

**50****8986011**

50x25

p.85

**120****8924111**

120x47

p.75

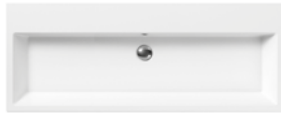
**100****8951111**

100x47

p.77

**40****8984011**

40x23

p.85

**100****8923111**

100x47

p.77

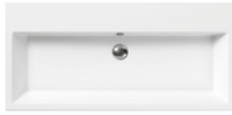
**80/d****8956111**

80x47

p.79

**80****8922111**

80x47

p.79

**80/s****8957111**

80x47

p.79

**60****8931111**

60x47

p.81

**60/d****8938111**

60x47

p.81

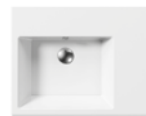
**50****8930111**

50x47

p.83

**60/s****8939111**

60x47

p.81

**45****8985111**

45x35

p.83



Wc e Bidet

Wc and Bidet

Wc und Bidet

Vasca

Bathtub

Badewanne

60/TS

8983011

60x38

p.87



50/TS

8982011

50x38

p.87



50/TI

894711

50x37

p.89



37/TI

895011

37x37

p.89



55/s

8934111

55x47

p.91



58/i

8933011

58x45

p.91



55

891211

8965111

55x36

p.93



55/F

891511

55x36

p.93



50

891811

8964111

50x36

p.95



50/F

891611

50x36

p.95



179

VAT80

179x80

p.97



Kube

In linea con la rinnovata tendenza stilistica di GSI ceramica, Kube afferma con decisione il nuovo profilo progettuale dell'azienda. L'unicità formale della collezione esprime una solidità propria degli oggetti dal carattere forte. Con Kube GSI ceramica propone lavabi installabili ad appoggio, incasso, semincasso o sospensione.

In line with the renewed stylistic trend of GSI Ceramics, Kube strongly asserts the company's new profile. The uniqueness of the collection expresses a real solidity typical of products with strong character. With Kube GSI proposes ceramic washbasins available counter top built-in semi-recessed and wall-hung fitting.

Im Einklang mit den jüngsten Trends bei GSI Ceramica steht der Stil von Kube für das neue Profil des Unternehmens. Die Einzigartigkeit der Kollektion drückt sich in der Robustheit aus, die für Produkte mit starkem Charakter typisch ist. In der Serie Kube präsentiert GSI Waschbecken, die sowohl als Aufsatz-, Einbau-, Halbeinbau- und Wandwaschbecken erhältlich sind.





Kube 100x47
Lavabo / Washbasin

Kube 55x36
Wc-Bidet











Kube 80x47
Lavabo / Washbasin



Kube 55x36
Wc-Bidet





Kube 50x38
Lavabo / Washbasin



Kube 100x47
Lavabo / Washbasin



Kube 58x45
Lavabo / Washbasin







Kube 150x50
Lavabo / Washbasin

Kube 55x36
Wc-Bidet









Kube 40x23
Lavabo / Washbasin





Pura

Lavabi

Washbasins

Waschbecken

Pura

120

8824111

120x50

**102**

8825111

102x52

**60/TS**

888311

60x38

**100**

8823111

100x50

**82**

8826111

82x52

**50/TS**

888211

50x38

**80**

8822111

80x50

**48/TS**

883511

Ø48

**80/d**

8856111

80x50

**60/TI**

883711

60x38

**42/TS**

882811

Ø42

**80/s**

8857111

80x50

**50/TI**

884711

50x38

**60**

8831111

60x50

**39/TI**

884611

Ø39

**55/U**

724311

55x38

**38/TI**

885011

38x38

**50/U**

724711

50x35



Wc e Bidet

Wc and Bidet

Wc und Bidet

Orinatoio

Urinal

Urinal

55

881211

8865111

55x36

**55**

881411

8862111

55x36

**39**

769711

39x31

**55/F**

881511

55x36

**55/F**

881011

55x36

**36**

889711

36x25

**55/F**

881111

8861111

54,5x35

**50**

881911

8869111

50x36

**50**

881811

8864111

50x36

**68**

881711

68x38

**50/F**

881611

50x36



Vasca

Bathtub

Badewanne

190

VAPR90

190x90



Pura

La collezione Pura si distingue per la razionalità progettuale e l'eleganza delle scelte stilistiche. Forme sobrie, che sapientemente bilanciano linee rette e morbidi arrotondamenti, frutto di un lungo lavoro di messa a punto a livello di design. La purezza minimalista delle linee fornisce ai prodotti appartenenti alla collezione di sanitari un'eleganza contemporanea ed una connotazione di lusso e raffinatezza secondo i valori di semplicità e accuratezza che contraddistinguono lo stile GSI.

The Pura collection is characterized by rational design and stylish elegance. Conservative shapes that skillfully balance straight lines and soft rounding are the result of a long design and development process. The understated purity of the lines gives the products in this range a contemporary elegance and a touch of luxury and refinement that fits with the simple but tasteful style of GSI.

Die Pura Kollektion ist durch ihr schlichtes Design und ihre stilvolle Eleganz gekennzeichnet. Zurückhaltende Formen, die kunstvoll gerade Linien und weiche Rundungen vereinen, sind das Ergebnis eines langen Design- und Entwicklungsprozesses. Die zarten und klaren Linien verleihen den Produkten dieser Serie eine zeitgenössische Eleganz und einen Hauch von Luxus und Raffinesse, die zum klaren aber geschmackvollen Stil von GSI passen.





Pura 102x52
Lavabo / Washbasin

Pura 55x36
Wc-Bidet

Pura 190x90
Vasca/Bath tub





Pura 60x38
Lavabo / Washbasin



Pura 68x38
Monoblocco / Close Coupled











Pura 100x50
Lavabo / Washbasin

Pura 55x36
Wc-Bidet





Pura 55x36
Wc-Bidet

Pura 100x50
Lavabo / Washbasin

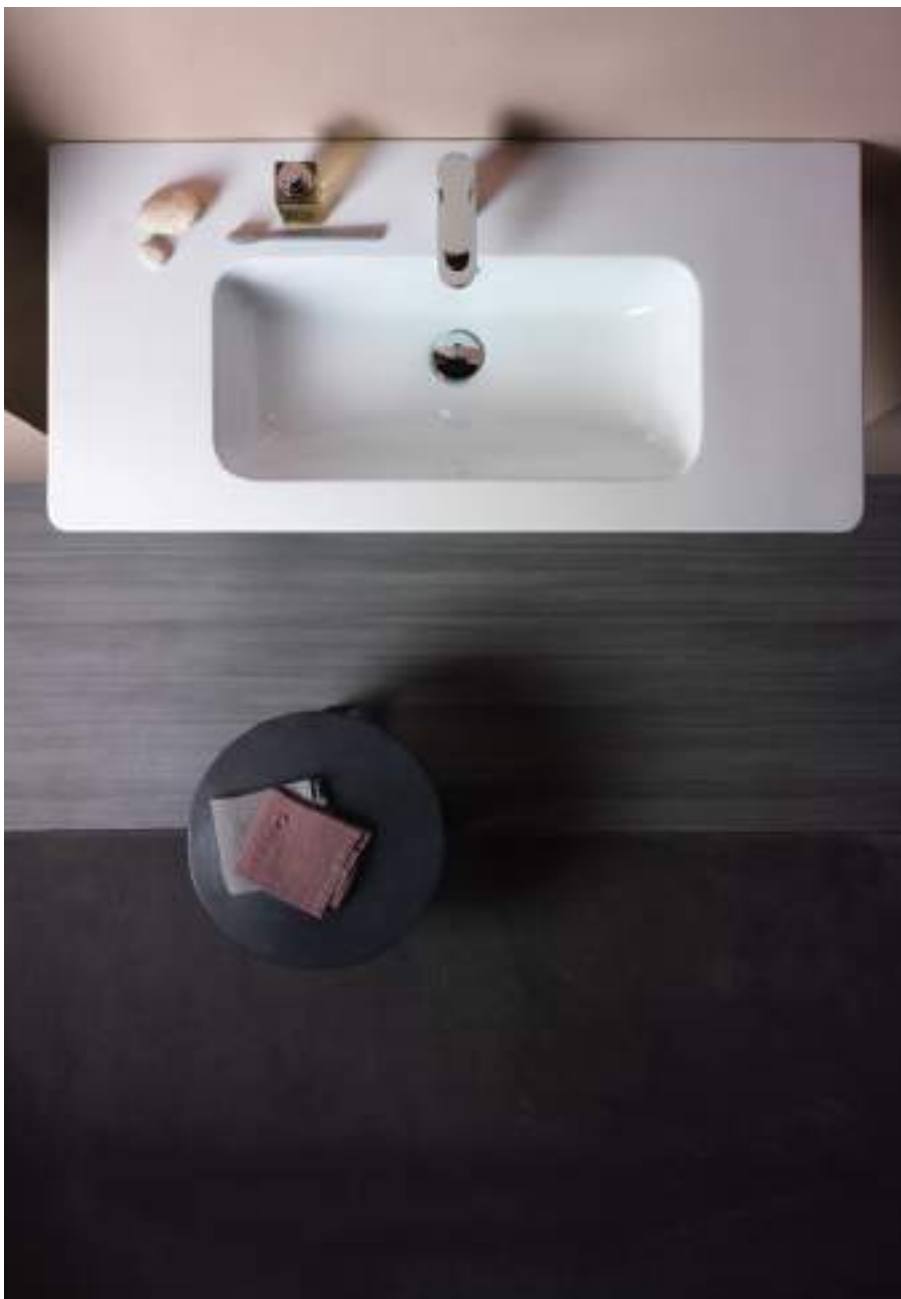

Pura 55x36
Wc-Bidet





Pura 55x36
Wc Swirflush











Modo

Lavabi

Washbasins

Waschbecken

Wc e Bidet

Wc and Bidet

Wc und Bidet

Modo

120

7724111

120x50

**100**

7723111

100x50

**80**

7722111

80x50

**65**

7732111

65x50

**50**

7785111

50x40

**55**

771211

7765111

55x38

**51**

771011

7760111

51x38



Vasca

Bathtub

Badewanne

190

VAM95
190x95



Modo

La collezione Modo ha un aspetto inconfondibile, grazie ad un profilo dinamico, a linee pulite e proporzionate che integrano eleganza ed armonia in maniera seducente. Modo offre un elevato standard qualitativo grazie ad un attento bilanciamento tra design, materiali di alta qualità ed elementi di confort in grado di soddisfare le esigenze dell'utente. Lavabi con bacini capienti, predisposizione per l'aggiunta di portasciugamani, possibilità di installazioni multiple, sospensione, incasso su piano o mobile. Wc per installazione a sospensione, con sistema di scarico a 4,5 litri d' acqua e copriwater disponibili anche con sistema di chiusura rallentata (soft-close). Tutto della collezione Modo è stato pensato per soddisfare le esigenze dei clienti GSI.

The Modo collection has a unique shape which seductively combines elegance and harmony thanks to its dynamic outline and its simple, proportional lines. Modo ensures high quality standards thanks to the perfect balance between design, high quality materials and convenient features to meet users' needs. Washbasins have ample bowls, with the option to add a towel rail, and there are multiple configurations available, such as wall-hung, inset or on a base cabinet or free standing. Wall-hung Wc provided with 4,5 litre waste system and toilet seat also available with soft-closing system. In this collection GSI ceramics has invested all its efforts to satisfy customers' needs.

Die Modo Kollektion hat eine einzigartige Form, die auf verführerische Weise mit ihren dynamischen Konturen und den proportionalen Linien Eleganz und Harmonie kombiniert. Modo gewährleistet hohe Qualitätsmaßstäbe aufgrund des perfekten Ausgleichs zwischen Design, hochwertigen Materialien und angenehmen Funktionen, die alle Anforderungen des Nutzers erfüllen. Die Waschbecken verfügen über weite Schalen und können optional mit einem Handtuchhalter ausgestattet werden. Sie sind als Wand-, Einbau-, Aufsatzwaschbecken und freistehende Waschbecken erhältlich. Das wandhängende WC mit 4,5 l Spülsystem ist auch mit WC-Sitz mit Soft Close-Mechanismus erhältlich. In dieser Kollektion bietet GSI Ceramica alles, was die Kundenanforderungen erfüllt.





Modo 120x50
Lavabo / Washbasin



Modo 190x95
Vasca / Bath tub











Classic

Lavabi

Washbasins

Waschbecken

Classic

125

8725111

125x54

**60/T**

874911

60x40

**55/U**

724311

55x38

**105**

8723111

105x54

**50/U**

724711

50x35

**90**

8788111

90x50

**75**

8787111

75x50

**60**

8731111

60x46



Wc e Bidet

Wc and Bidet

Wc und Bidet

Vasca

Bathtub

Badewanne

55

871211

8765111

55x37



54

871011

871111

8762111

54x37



175

VAL1

VAL2

175x82



70

871711

70x37



Classic

La collezione Classic esprime l'idea di eleganza secondo GSI ceramica attraverso un linguaggio subito riconoscibile per i tratti stilistici richiamati dai prodotti che fanno parte della famiglia di sanitari.

Un linguaggio non a caso classico che caratterizza sia i lavabi che i sanitari e la vasca da bagno con forme equilibrate ed armoniose di chiara ispirazione neoclassica. Prodotti senza tempo, dunque, che possono arredare l'ambiente bagno ricreando atmosfere tradizionali di eleganza e stile, ed in grado di evocare nuove forme di romanticismo così come dimostrano i nuovi sanitari sospesi.

The Classic collection exudes GSI's interpretation of elegance through the immediately recognizable stylistic traits of this product range: the classic shape of the washbasins, toilets, bidets and bath tubs, the products have balanced, harmonious shapes with obvious neoclassical inspiration. These are timeless products, which can furnish the bathroom recreating traditional atmosphere of stylish elegance, and to evoke new forms of romanticism as reflected in the new wall-hung sanitaryware.

Die Classic Kollektion verströmt die Eleganz nach der Interpretation von GSI über die sofort erkennbaren Stilmerkmale der Produktreihe: Als klassische Form der Waschbecken, WCs, Bidets und Badewannen haben die Produkte eine ausgewogene, harmonische Gestalt und sind offensichtlich vom Neoklassizismus inspiriert. Sie sind zeitlose Produkte, die Badezimmer mit einer traditionellen Atmosphäre stilvoller Eleganz ausstatten und neue romantische Formen wie in der neuen wandhängenden Sanitärkeramik aufweisen.





Classic 75x50
Lavabo/Washbasin

Classic 54x37
Wc-Bidet

Classic 175x82
Vasca/Bath tub





Classic 175x82
Vasca/Bathub



Classic 55x37
Wc-Bidet





Classic 125X84
Lavabo/Washbasin

Classic 54X37
Wc-Bidet





Classic 105x54
Lavabo/Washbasin

Classic 70x37
Monoblocco / Close coupled

Classic 54x37
Bidet



Classic 90x50
Lavabo / Washbasin

Classic 54x37
Mc-Bidet





Community

Lavabi

Washbasins

Waschbecken

Wc e Bidet

Wc and Bidet

Wc und Bidet

Community

70

7631011

70x60



70

761811

70x37



Orinatoio

Urinal

Urinal

Piatti doccia H6

Shower trays H6

H6 Duschwannen

39

769711

39x31



140

358711

140x80



120

359811

120x80



120

359911

120x70



100

358611

100x80



100

358911

100x70



90

359711

90x72



90/q

339711

90x90



80/q

338611

80x80



90

349711

90x90



80

348611

80x80



Community

Community è la proposta GSI ceramica per l'ambiente bagno pubblico e collettivo. Si tratta di una collezione di sanitari che offre delle soluzioni molto particolari sia in termini di design che dal punto di vista delle possibilità di impiego. Community prevede una linea di prodotti per un'utenza diversamente abile.

Community is GSI's product range for the public environment. The collection offers specific solutions in terms of design and use. The Community collection includes a series for disabled users.

Community ist die Produktserie von CSI für öffentliche Bereiche. Die Kollektion bietet besondere Lösungen hinsichtlich Design und Gebrauch. Zu der Community Kollektion gehört auch eine Serie für behinderte Nutzer.





Community 70x60
Lavabo / Washbasin



Community 70x37
Wc



H6 120x80
Piatto doccia / Shower tray



Community 70x60
Lavabo / Washbasin



Community 70x37
WC





H6 120x80
Platto doccia / Shower tray





H6 80x80
Piatto doccia / Shower tray

H6 90x90
Platto doccia / Shower tray



Disegni tecnici
Technical drawings
Technische
Zeichnungen

Sand

Lavabi

Element Free

Washbasins

Element Free

Element Free

Waschbecken

Sand

h85

Description	Washbasin
Code	905811
	905911
Dimensions	55x38 h85
Weight	Kg 47
Capacity	Lt 11
Overflow	CL 00
Installation	freestanding
Taphole	0

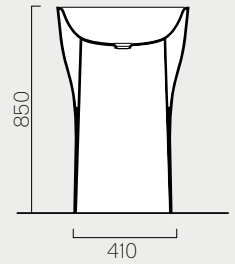
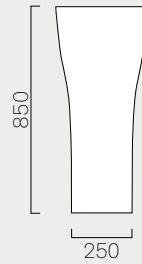
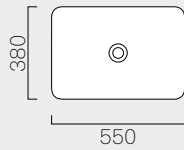

Lavabi

Washbasins

Waschbecken

125

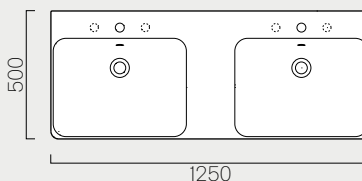

Description	Washbasin
Code	9052111
Dimensions	125x50 h19
Overflow	CL 25
Installation	Wall-hung, built-in
Taphole	1 (3)

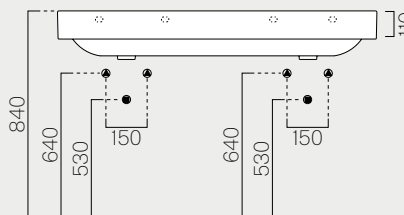
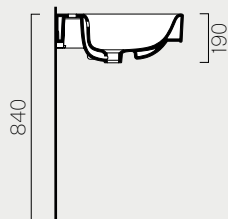

120

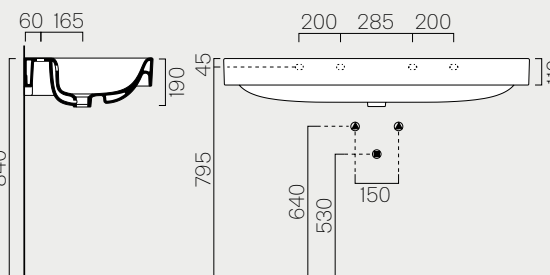
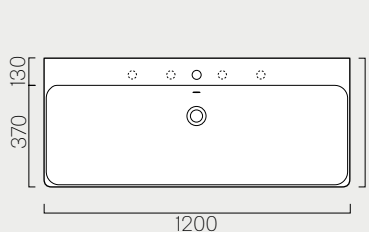

Description	Washbasin
Code	9024111
Dimensions	120x50 h19
Weight	Kg 33,7
Capacity	Lt 20
Overflow	CL 25
Installation	Wall-hung, built-in
Taphole	1 (5)

100

Description	Washbasin
Code	9023111
Dimensions	100x50 h19
Weight	Kg 28,7
Capacity	Lt 18,5
Overflow	CL 25
Installation	Wall-hung, built-in
Taphole	1(5)

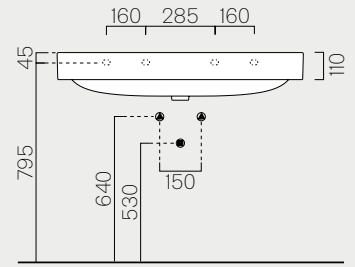
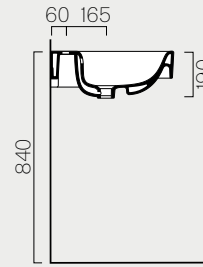
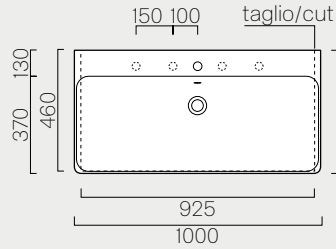

100

Description	Washbasin
Code	9051111
Dimensions	100x50 h19
Weight	Kg 29
Capacity	Lt 9
Overflow	CL 25
Installation	Wall-hung, built-in
Taphole	1(3)

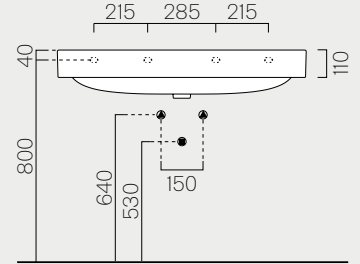
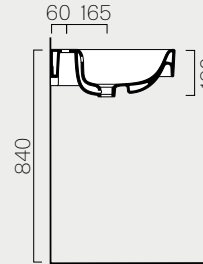
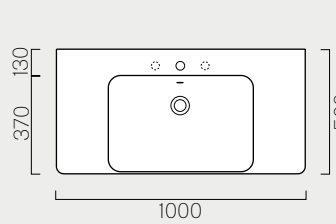

80

Description	Washbasin
Code	9022111
Dimensions	80x50 h19
Weight	Kg 23,7
Capacity	Lt 14
Overflow	CL 25
Installation	Wall-hung, built-in
Taphole	1(3)

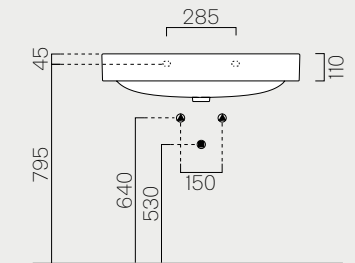
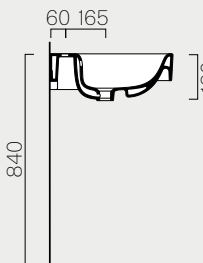
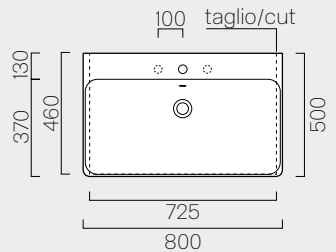

60

Description	Washbasin
Code	9031111
Dimensions	60x50 h19
Weight	Kg 18,5
Capacity	Lt 9
Overflow	CL 25
Installation	Wall-hung, built-in
Taphole	1(3)

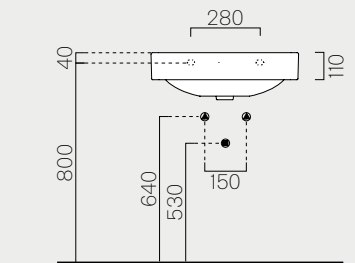
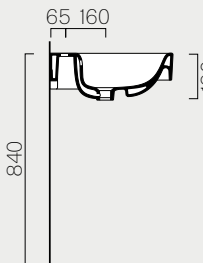
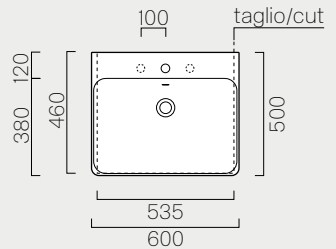

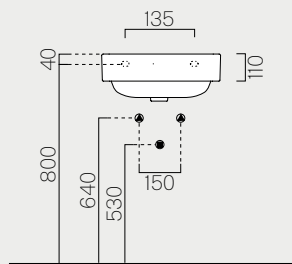
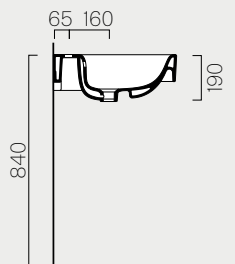
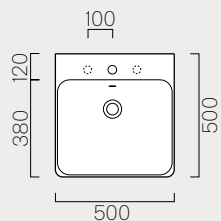
50

Description	Washbasin
Code	9085111
Dimensions	50x50 h19
Weight	Kg 15,7
Capacity	Lt 14,5
Overflow	CL 25
Installation	Wall-hung, built-in
Taphole	1 (3)

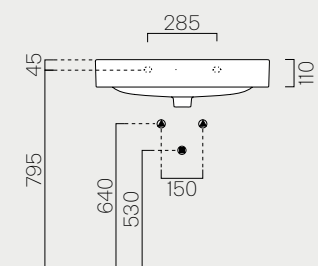
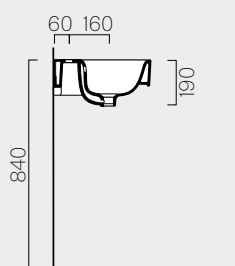
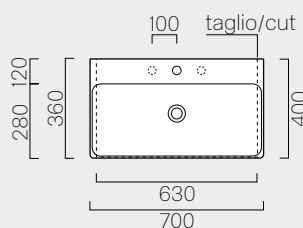
70

Description	Washbasin
Code	9087111
Dimensions	70x40 h19
Weight	Kg 16,5
Capacity	Lt 9
Overflow	CL 25
Installation	Wall-hung, built-in
Taphole	1 (3)

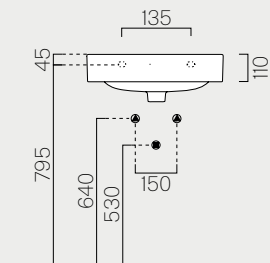
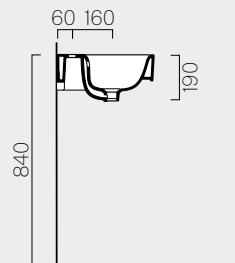
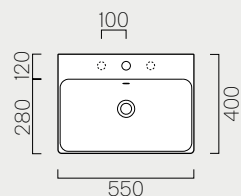
55

Description	Washbasin
Code	9086111
Dimensions	55x40 h19
Weight	Kg 12,7
Capacity	Lt 7
Overflow	CL 25
Installation	Wall-hung, built-in
Taphole	1 (3)

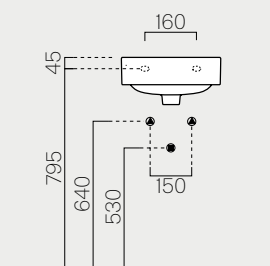
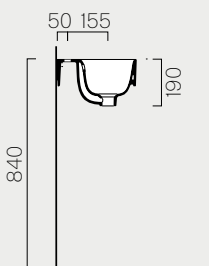
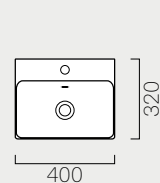
40

Description	Washbasin
Code	9084111
Dimensions	40x32 h19
Weight	Kg 9,5
Capacity	Lt 4,5
Overflow	CL 25
Installation	Wall-hung, built-in
Taphole	1

60/TS

Description	Washbasin
Code	908311
Dimensions	60x38 h14
Weight	Kg 12,4
Capacity	Lt 8,5
Overflow	CL 00
Installation	Countertop
Taphole	0

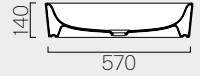
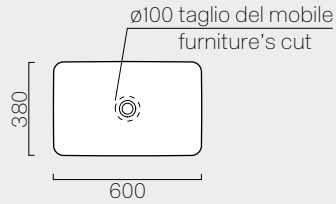

50/TS

Description	Washbasin
Code	908211
Dimensions	50x38 h14
Weight	Kg 10,8
Capacity	Lt 6
Overflow	CL 00
Installation	Countertop
Taphole	0

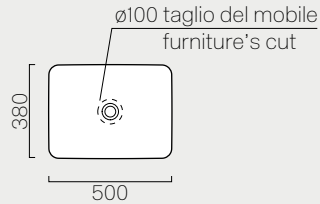

48/TS

Description	Washbasin
Code	903511
Dimensions	48 h14
Weight	Kg 11
Capacity	Lt 7,5
Overflow	CL 00
Installation	Countertop
Taphole	0



42/TS

Description	Washbasin
Code	904811
Dimensions	42 h14
Weight	Kg 9,4
Capacity	Lt 4,5
Overflow	CL 00
Installation	Countertop
Taphole	0

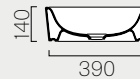

70/TO

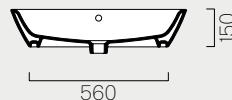
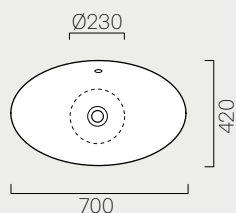

Description	Washbasin
Code	904111
Dimensions	70x42 h15
Weight	Kg 14,2
Capacity	Lt 8,5
Overflow	CL 25
Installation	Countertop
Taphole	0

60/TO

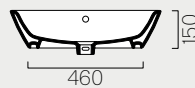
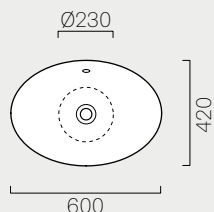

Description	Washbasin
Code	904911
Dimensions	60x42 h15
Weight	Kg 12
Capacity	Lt 7
Overflow	CL 25
Installation	Countertop
Taphole	0

42/TO

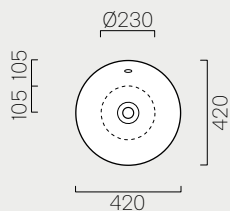

Description	Washbasin
Code	902811
Dimensions	42 h15
Weight	Kg 9,1
Capacity	Lt 4,5
Overflow	CL 25
Installation	Countertop
Taphole	0

70/TE

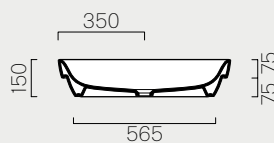
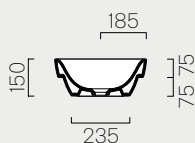
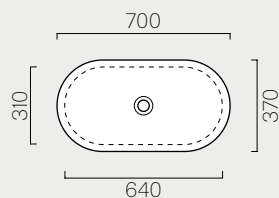

Description	Washbasin
Code	908911
Dimensions	70x37 h15
Weight	Kg 13,3
Capacity	Lt 11
Overflow	CL 00
Installation	Countertop, Built-in
Taphole	0

55/TE

Description	Washbasin
Code	903011
Dimensions	55x35 h15
Weight	Kg 9,7
Capacity	Lt 6
Overflow	CL 00
Installation	Countertop, Built-in
Taphole	0

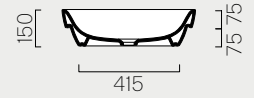
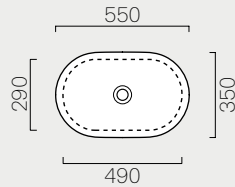
**45/TE**

Description	Washbasin
Code	903411
Dimensions	45 h15
Weight	Kg 9,6
Capacity	Lt 7
Overflow	CL 00
Installation	Countertop, Built-in
Taphole	0

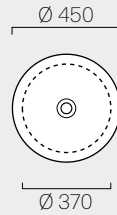
**35/TE**

Description	Washbasin
Code	905011
Dimensions	35 h15
Weight	Kg 6
Capacity	Lt 4,5
Overflow	CL 00
Installation	Countertop, Built-in
Taphole	0

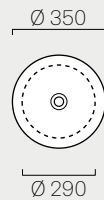
**60/1**

Description	Washbasin
Code	9033111
Dimensions	60x45 h16
Weight	Kg 13,5
Capacity	Lt 4,5
Overflow	CL 25
Installation	Built-in
Taphole	1

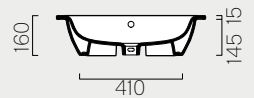
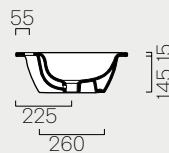
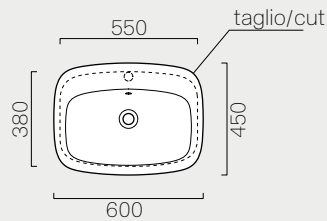

Wc e Bidet

Wc and Bidet

Wc und Bidet

55

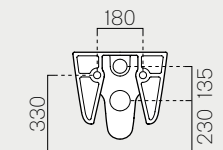
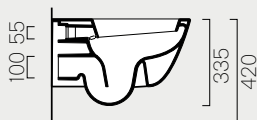
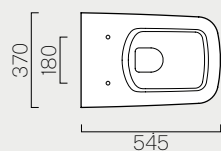

Description	Wc
Code	901211
Dimensions	54,5x37
Weight	Kg 21,3
Flush system	Standard
Installation	wall-hung

55

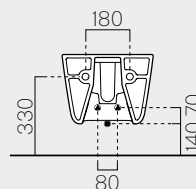
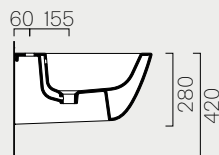
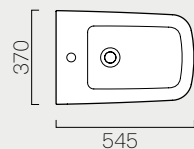

Description	Bidet
Code	906511
Dimensions	54,5x37
Weight	Kg 17,3
Overflow	CL 25
Installation	wall-hung
Taphole	1

55/F

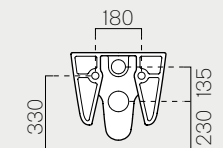
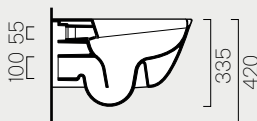
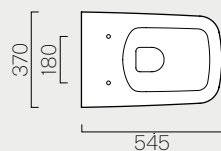

Description	Wc
Code	901511
Dimensions	54,5x37
Weight	Kg 20,5
Flush system	Swirlflush
Installation	wall-hung

50

Description	Wc
Code	901811
Dimensions	50x37
Weight	Kg 19,5
Flush system	Standard
Installation	wall-hung

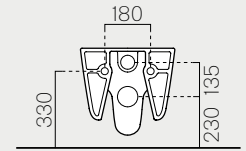
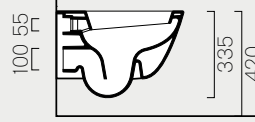
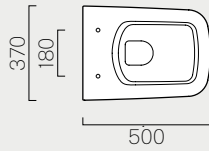

50

Description	Bidet
Code	906411
Dimensions	50x37
Weight	Kg 15,9
Overflow	CL 25
Installation	wall-hung
Taphole	1

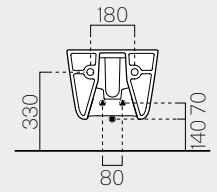
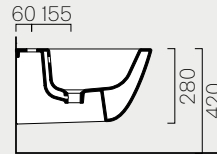
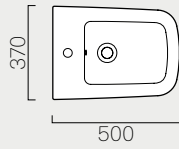

50/F

Description	Wc
Code	901611
Dimensions	51x37
Flush system	Swirlflush
Installation	wall-hung

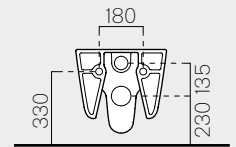
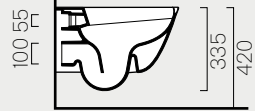
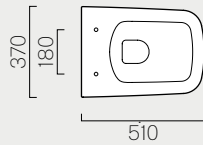

55

Description	Wc
Code	901411
Dimensions	54,5x37
Weight	Kg 26
Flush system	Standard
Installation	Floor standing

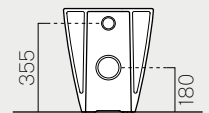
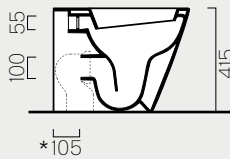
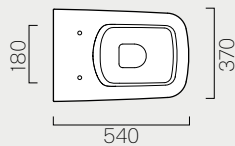

Curva tecnica
Technical curve



Codice
Codes

MCURVA

MCURVAS

MCURVA90

Interasse
Distance

* 105

* Da 165 a 180 mm
* From 165 to 180 mm

* Da 60 a 80 mm
* From 60 to 80 mm

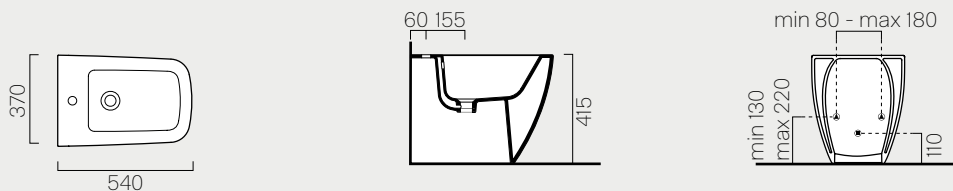

Description	Bidet
Code	9062111
Dimensions	54,5x37
Weight	Kg 23,1
Overflow	CL 25
Installation	Floor standing
Taphole	1

Vasca

Bathtub

Badewanne

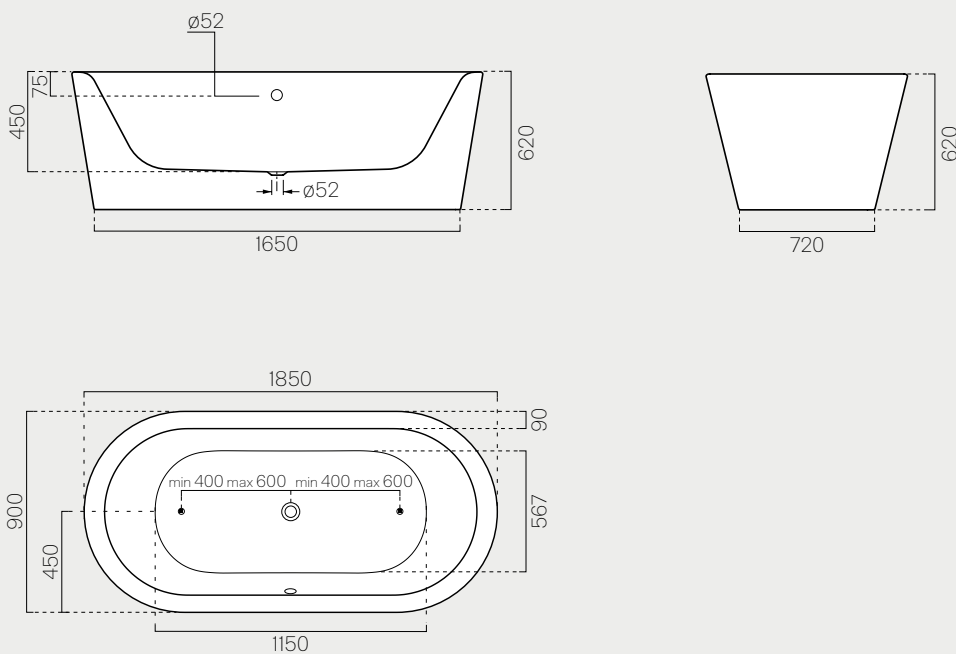

185

Description	Bathtub
Code	VASAND90
Dimensions	185X90 h62
Weight	Kg 58
Installation	freestanding
Material	acrylic

180

Description	Bathtub
Code	VASAND80
Dimensions	180X80 h45
Weight	Kg 36
Installation	Built-in
Material	acrylic

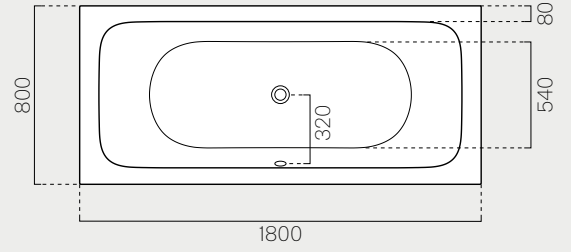
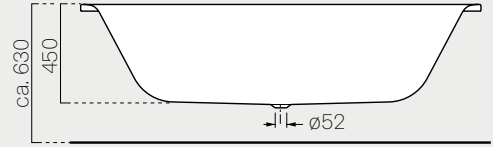

Disegni tecnici
Technical drawings
Technische
Zeichnungen

Norm

Lavabi

Element Free

Washbasins

Element Free

Element Free

Waschbecken

Norm

h85

Description	Washbasin
Code	7559011
	7558011
Dimensions	56x40 h85
Weight	Kg 47,2
Capacity	Lt 14
Overflow	CL 00
Installation	freestanding
Taphole	0

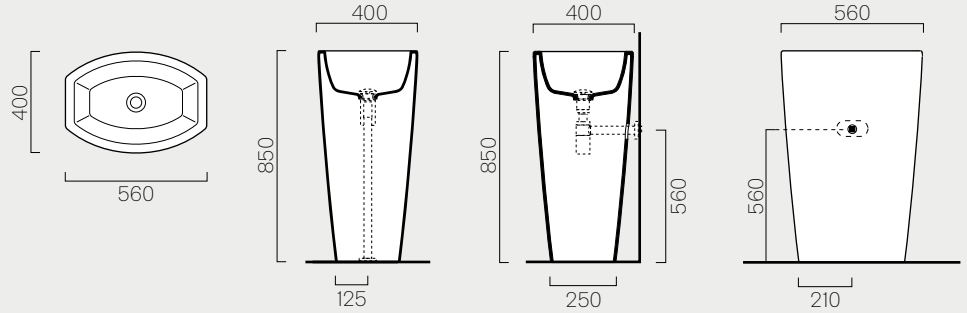

h85

Description	Washbasin
Code	7557111
	7556111
Dimensions	56x40 h85
Weight	Kg 49
Capacity	Lt 10
Overflow	CL 25
Installation	freestanding
Taphole	1

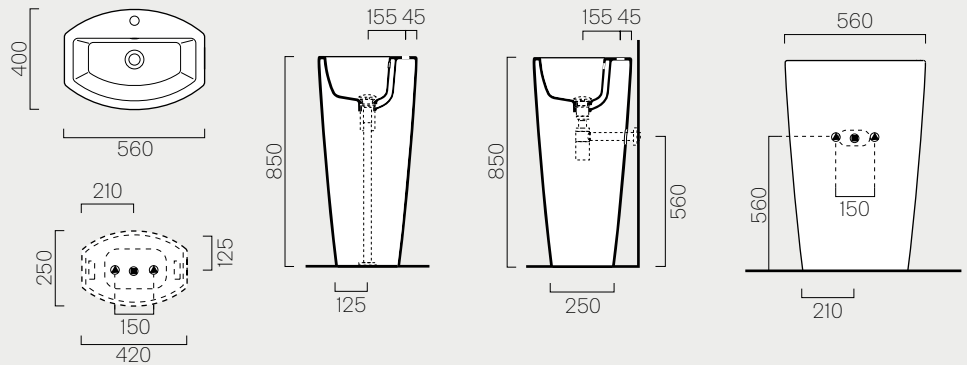

Lavabi

Washbasins

Waschbecken

125

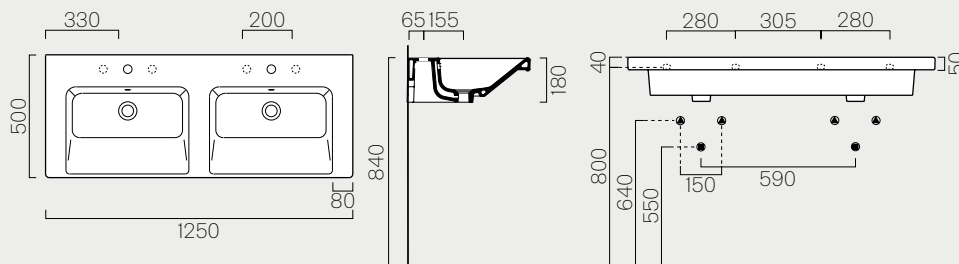

Description	Washbasin
Code	8625111
Dimensions	125x50 h18
Weight	Kg 34,8
Capacity	Lt 8
Overflow	CL 25
Installation	wall-hung, built-in
Taphole	1 (3)

120

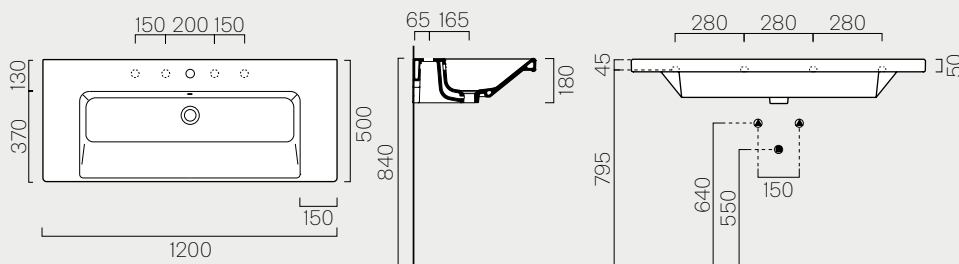

Description	Washbasin
Code	8624111
Dimensions	120x50 h18
Weight	Kg 30
Capacity	Lt 14
Overflow	CL 25
Installation	wall-hung, built-in
Taphole	1 (5)

100

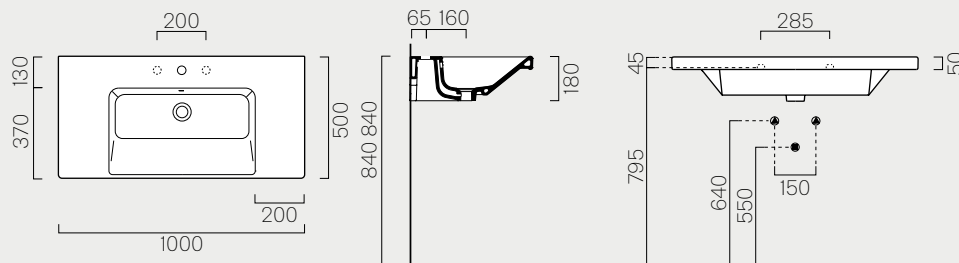

Description	Washbasin
Code	8623111
Dimensions	100x50 h18
Weight	Kg 26
Capacity	Lt 9,5
Overflow	CL 25
Installation	wall-hung, built-in
Taphole	1 (3)

90

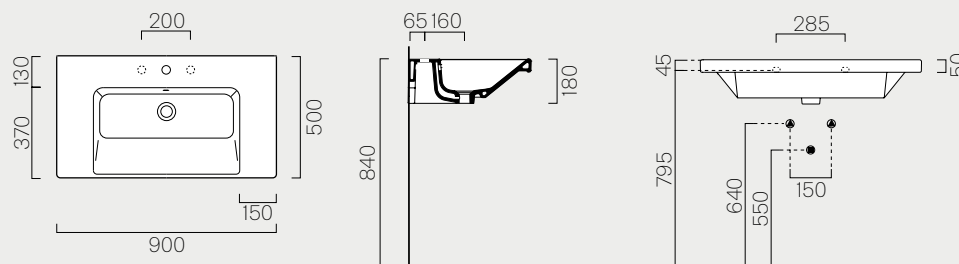

Description	Washbasin
Code	8688111
Dimensions	90x50 h18
Weight	Kg 24,6
Capacity	Lt 9,5
Overflow	CL 25
Installation	wall-hung, built-in
Taphole	1 (3)

75

Description	Washbasin
Code	8687111
Dimensions	75x50 h18
Weight	Kg 20,1
Capacity	Lt 8,5
Overflow	CL 25
Installation	wall-hung, built-in
Taphole	1 (3)

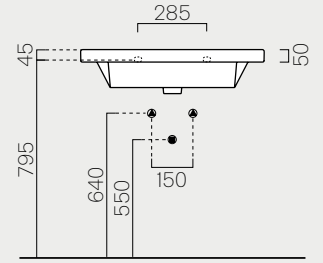
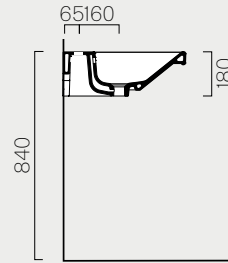
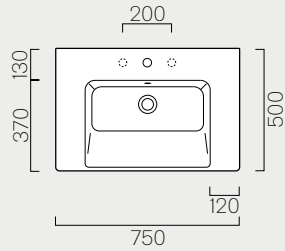

60

Description	Washbasin
Code	8683111
Dimensions	60x50 h18
Weight	Kg 18,1
Capacity	Lt 6,5
Overflow	CL 25
Installation	wall-hung, built-in
Taphole	1 (3)

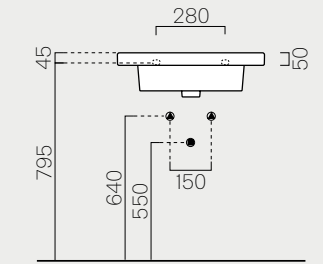
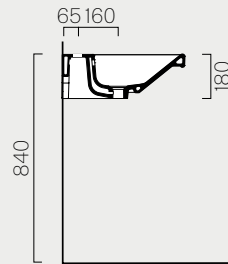
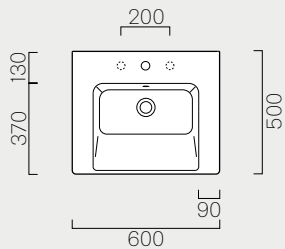

42

Description	Washbasin
Code	8684111
Dimensions	42x34 h17
Weight	Kg 9,1
Capacity	Lt 3
Overflow	CL 25
Installation	wall-hung, built-in
Taphole	1

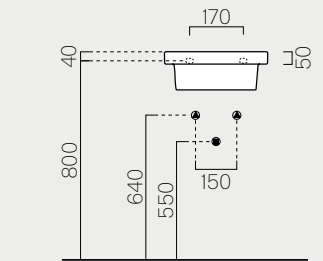
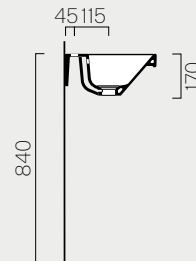
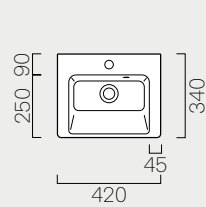

35

Description	Washbasin
Code	8650111
Dimensions	35x26 h12
Weight	Kg 5,6
Capacity	Lt 1,8
Overflow	CL 00
Installation	wall-hung, built-in
Taphole	1

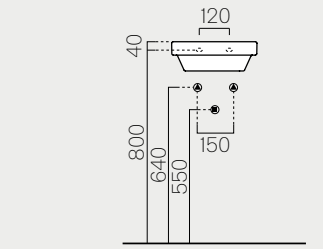
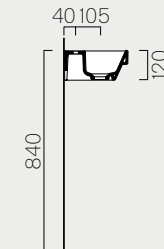
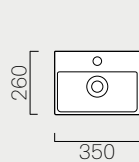

Wc e Bidet

Wc and Bidet

Wc und Bidet

55

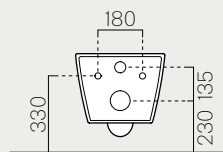
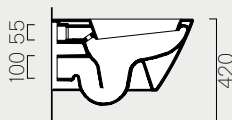
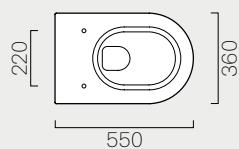

Description	Wc
Code	861211
Dimensions	55x36
Weight	Kg 24
Flush system	Standard
Installation	wall-hung

55

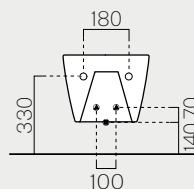
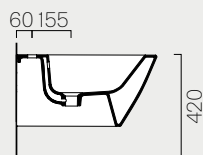
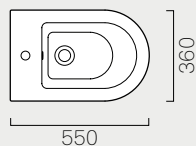

Description	Bidet
Code	861511
Dimensions	55x36
Weight	Kg 16,3
Overflow	CL 25
Installation	wall-hung
Taphole	1

55/F

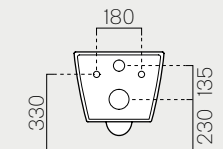
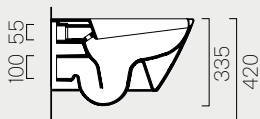
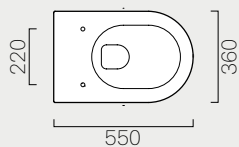

Description	Wc
Code	861511
Dimensions	55x36
Weight	Kg 23,7
Flush system	Swirlflush
Installation	wall-hung

50

Description	Wc
Code	861811
Dimensions	50x36
Weight	Kg 16,5
Flush system	Standard
Installation	wall-hung

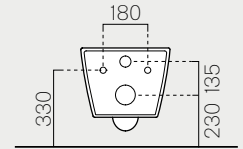
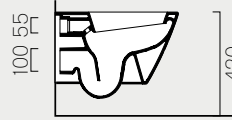
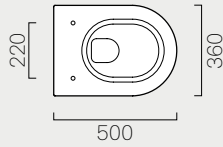

50

Description	Bidet
Code	8664111
Dimensions	50x36
Weight	Kg 15,3
Overflow	CL 25
Installation	wall-hung
Taphole	1

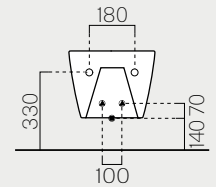
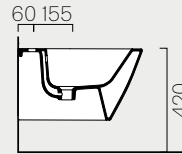
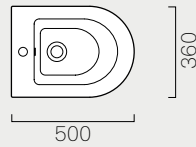

50/F

Description	Wc
Code	861611
Dimensions	50x36
Weight	Kg 22,3
Flush system	Swirflush
Installation	wall-hung

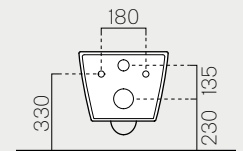
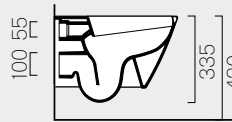
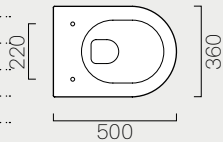

45

Description	Wc
Code	861011
Dimensions	45x35
Weight	Kg 18,6
Flush system	Standard
Installation	wall-hung

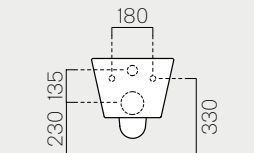
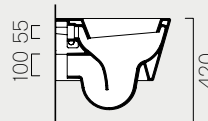
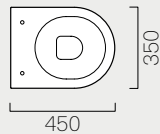

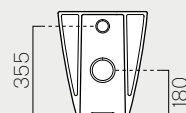
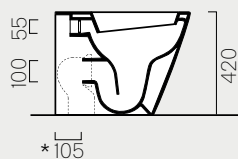
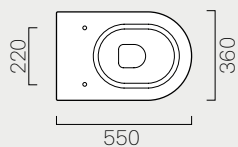

Description	Wc
Code	861411
Dimensions	55x36
Weight	Kg 24,8
Flush system	Standard
Installation	Floor standing

Curva tecnica
Technical curve



Codice

MCURVA

MCURVA90

Codes

Interasse
Distance

* 105

* 60

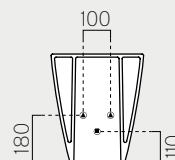
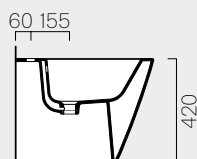
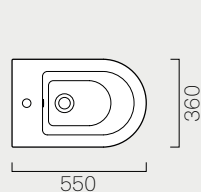

Description	Bidet
Code	8662111
Dimensions	55x36
Weight	Kg 20,8
Overflow	CL 25
Installation	Floor standing
Taphole	1

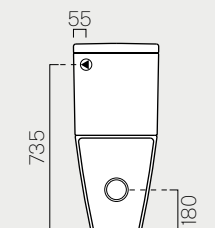
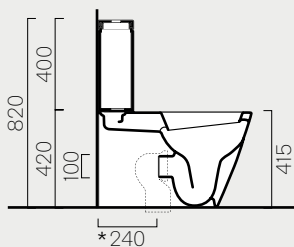
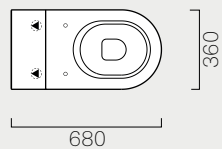

Description	Wc
Code	861711
Dimensions	68x36
Weight	Kg 31,8
Flush system	Standard
Installation	Floor standing

Vista dal retro.
View from the back.
Blick von hinten.

Curva tecnica
Technical curve



Codice

MCURVAS

MCURVA90

Codes

Interasse
Distance

* Da 230 a 305 mm
* From 230 to 305 mm

* Da 80 a 205 mm
* From 80 to 205 mm

Cassetta

Description	Cistern
Code	868111
Dimensions	17x31 43h
Weight	Kg 13,5

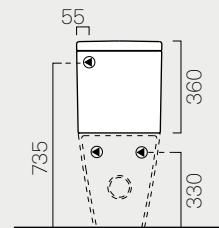
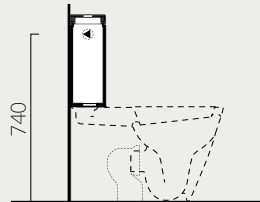
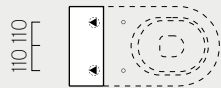

Vista dal retro.
View from the back.
Blick von hinten.

Scocca

Description	Ceramic Cover
Code	869111
Dimensions	13x35,5 46h
Weight	Kg 9,6

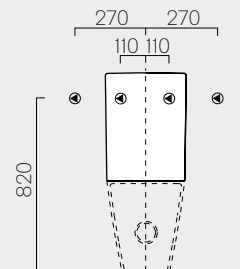
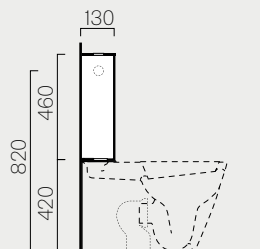

Vista dal retro.
View from the back.
Blick von hinten.

Disegni tecnici
Technical drawings
Technische
Zeichnungen

Kube

Lavabi

Washbasins

Waschbecken

150

Description	Washbasin
Code	8963111
Dimensions	150x50 h16
Weight	Kg 40,5
Capacity	Lt 9
Overflow	CL 25
Installation	wall-hung, countertop
Taphole	1(3)

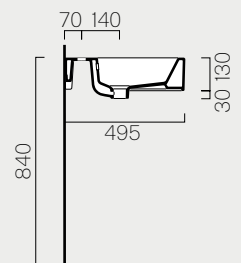
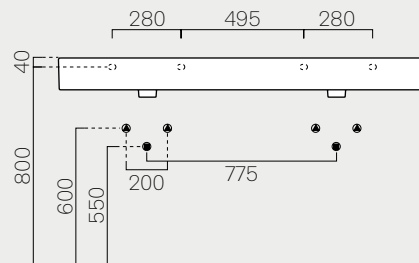
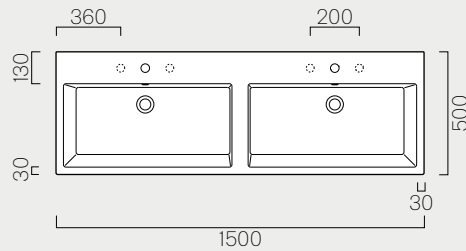

120

Description	Washbasin
Code	8924111
Dimensions	120x47 h16
Weight	Kg 28,7
Capacity	Lt 13,5
Overflow	CL 25
Installation	wall-hung, countertop
Taphole	1 (5)

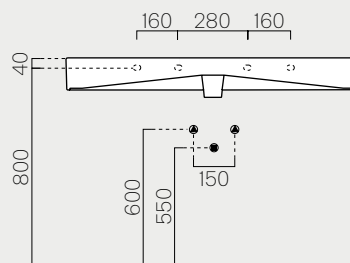
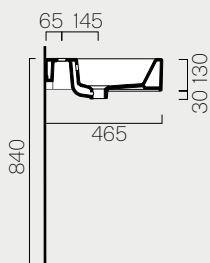
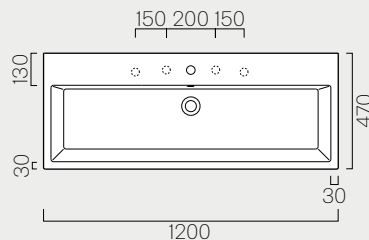

120

Description	Washbasin
Code	8952111
Dimensions	120x47 h16
Weight	Kg 28
Capacity	Lt 8
Overflow	CL 25
Installation	wall-hung, countertop
Taphole	1 (3)

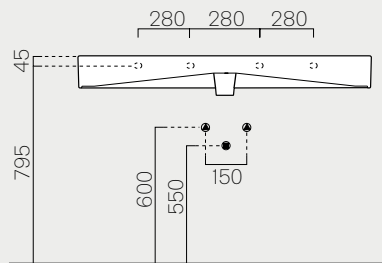
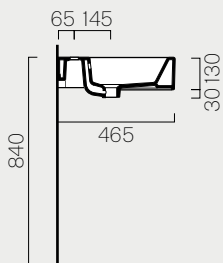
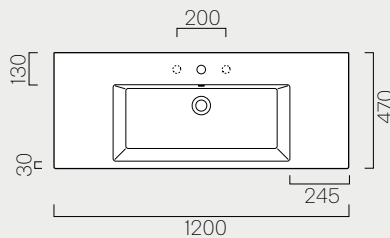

100

Description	Washbasin
Code	8923111
Dimensions	100x47 h16
Weight	Kg 23,5
Capacity	Lt 12
Overflow	CL 25
Installation	wall-hung, countertop
Taphole	1(5)

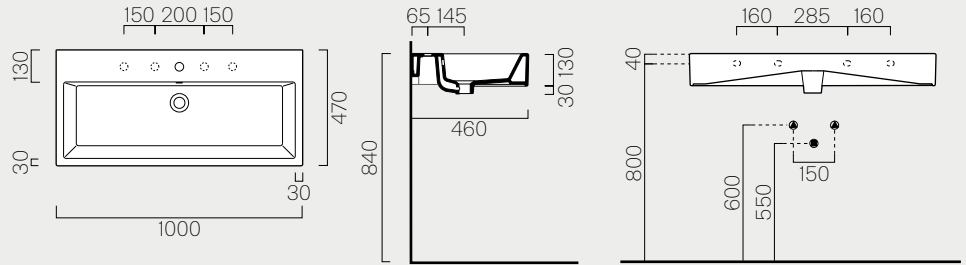

100

Description	Washbasin
Code	8951111
Dimensions	100x47 h16
Weight	Kg 27,4
Capacity	Lt 6
Overflow	CL 25
Installation	wall-hung, countertop
Taphole	1(3)

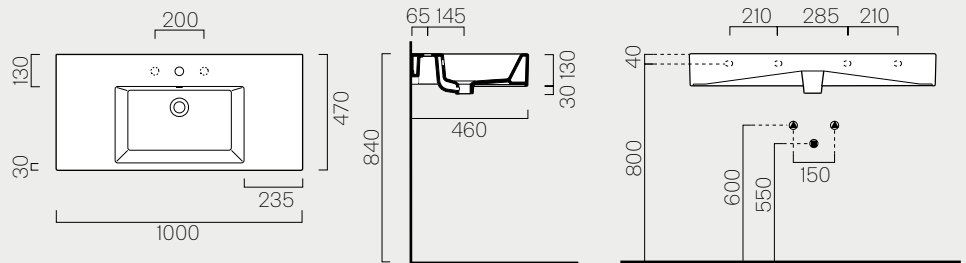

80

Description	Washbasin
Code	8922111
Dimensions	80x47 h16
Weight	Kg 21,6
Capacity	Lt 8,5
Overflow	CL 25
Installation	wall-hung, countertop
Taphole	1(3)

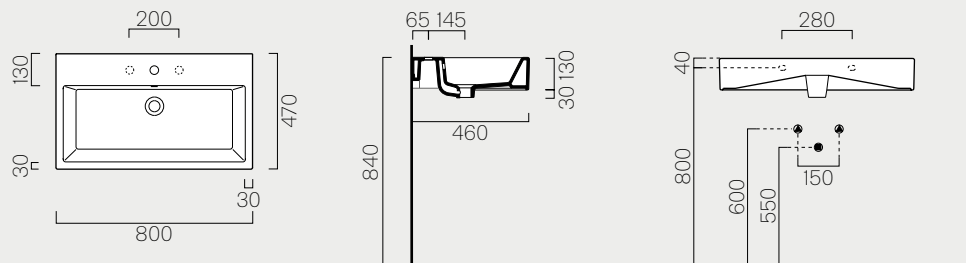

80/d

Description	Washbasin
Code	8956111
Dimensions	80x47 h16
Weight	Kg 20,3
Capacity	Lt 6
Overflow	CL 25
Installation	wall-hung, countertop
Taphole	1(3)

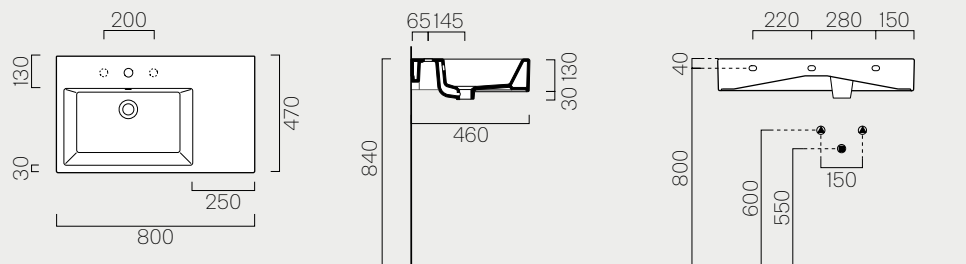

Vista dal retro.
View from the back.
Blick von hinten.

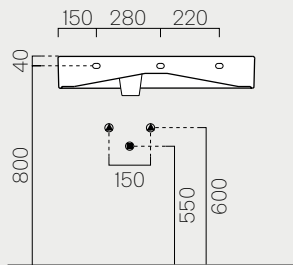
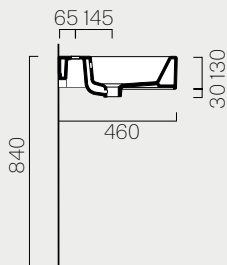
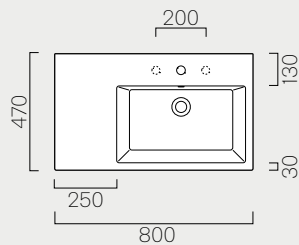
80/s

Description	Washbasin
Code	8957111
Dimensions	80x47 h16
Weight	Kg 20,3
Capacity	Lt 6
Overflow	CL 25
Installation	wall-hung, countertop
Taphole	1 (3)

Vista dal retro.
View from the back.
Blick von hinten.

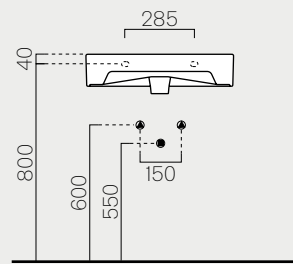
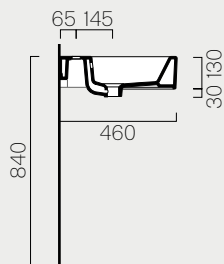
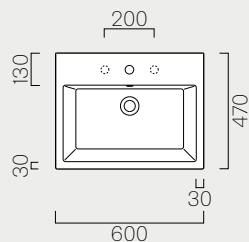
60

Description	Washbasin
Code	8931111
Dimensions	60x47 h16
Weight	Kg 16,5
Capacity	Lt 6,5
Overflow	CL 25
Installation	wall-hung, countertop
Taphole	1 (3)

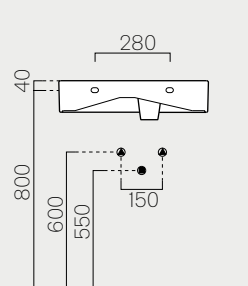
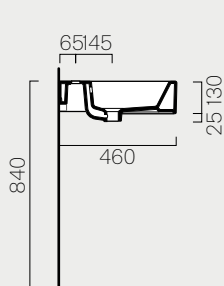
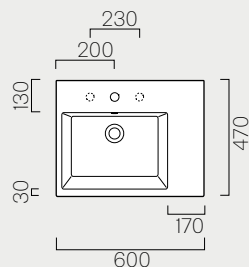
60/d

Description	Washbasin
Code	8938111
Dimensions	60x47 h16
Weight	Kg 16,9
Capacity	Lt 4,5
Overflow	CL 25
Installation	wall-hung, countertop
Taphole	1 (3)

Vista dal retro.
View from the back.
Blick von hinten.

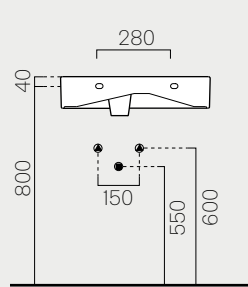
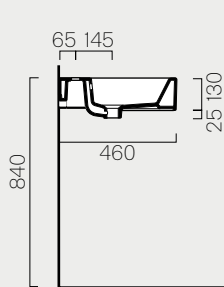
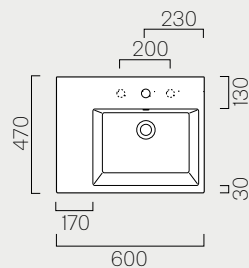
60/s

Description	Washbasin
Code	8939111
Dimensions	60x47 h16
Weight	Kg 16,9
Capacity	Lt 4,5
Overflow	CL 25
Installation	wall-hung, countertop
Taphole	1 (3)

Vista dal retro.
View from the back.
Blick von hinten.

50

Description	Washbasin
Code	8930111
Dimensions	50x47 h16
Weight	Kg 14,3
Capacity	Lt 5
Overflow	CL 25
Installation	wall-hung, countertop
Taphole	1 (3)

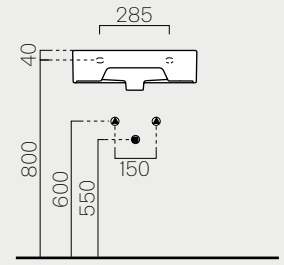
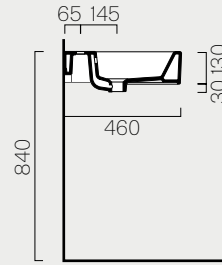
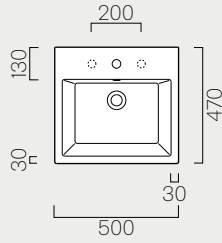

45

Description	Washbasin
Code	8985111
Dimensions	45x35 h13
Weight	Kg 10,4
Capacity	Lt 4
Overflow	CL 25
Installation	wall-hung, countertop
Taphole	1 (3)

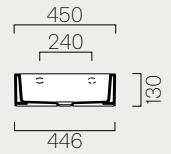
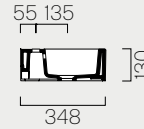
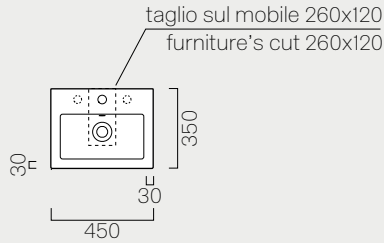

50

Description	Washbasin
Code	8986011
Dimensions	50x25 h13
Weight	Kg 10
Capacity	Lt 4
Overflow	CL 00
Installation	countertop
Taphole	0 (1)

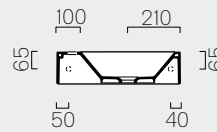
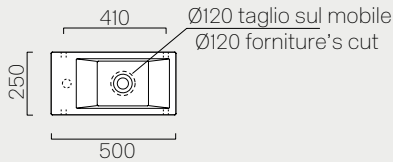

40

Description	Washbasin
Code	8984011
Dimensions	40x23 h1,5
Weight	Kg 7
Capacity	Lt 2
Overflow	CL 00
Installation	countertop
Taphole	0 (1)

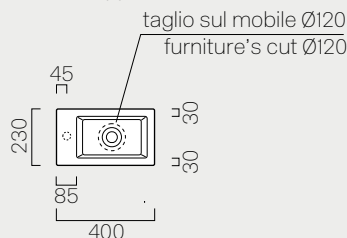
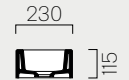
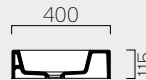
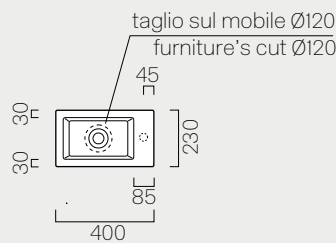

60/TS

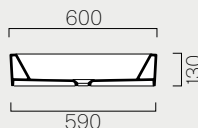
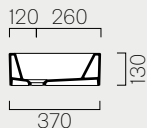
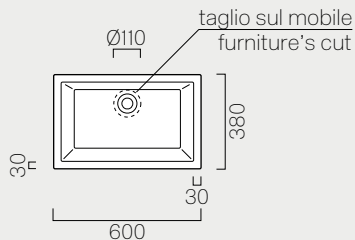

Description	Washbasin
Code	8983011
Dimensions	60x38 h13
Weight	Kg 15,6
Capacity	Lt 8,5
Overflow	CL 00
Installation	countertop
Taphole	0

50/TS

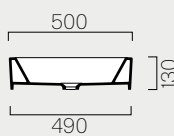
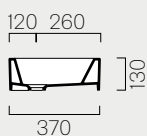
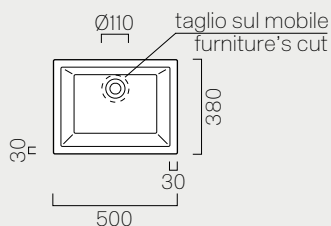

Description	Washbasin
Code	8982011
Dimensions	50x38 h13
Weight	Kg 10,7
Capacity	Lt 7
Overflow	CL 00
Installation	countertop
Taphole	0

50/TI

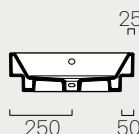
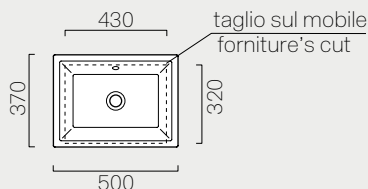

Description	Washbasin
Code	894711
Dimensions	50x37 h15,5
Weight	Kg 12,6
Capacity	Lt 4
Overflow	CL 25
Installation	countertop, built-in
Taphole	0

37/TI

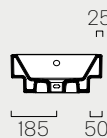
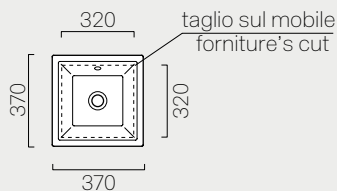

Description	Washbasin
Code	895011
Dimensions	37x37 h15,5
Weight	Kg 10
Capacity	Lt 3
Overflow	CL 25
Installation	countertop, built-in
Taphole	0

55/s

Description	Washbasin
Code	8934111
Dimensions	55x47 h15,5
Weight	Kg 16
Capacity	Lt 4
Overflow	CL 25
Installation	semi-recessed
Taphole	1 (3)

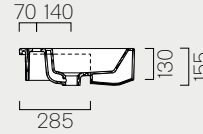
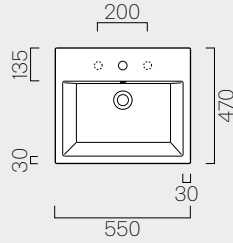

58/1

Description	Washbasin
Code	8933011
Dimensions	58x45 h16,5
Weight	Kg 14,6
Capacity	Lt 4
Overflow	CL 25
Installation	built-in
Taphole	0 (1)

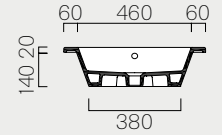
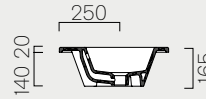
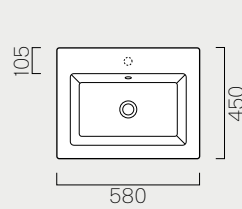

Wc e Bidet

Wc and Bidet

Wc und Bidet

55

Description	Wc
Code	891211
Dimensions	55x36
Weight	Kg 20,4
Flush system	standard
Installation	wall-hung

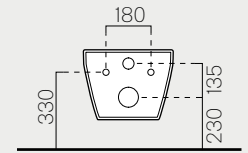
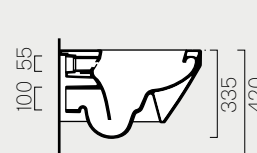
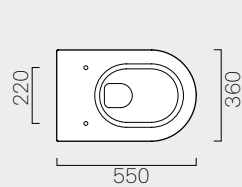

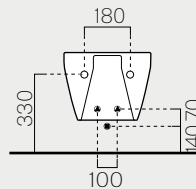
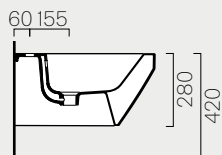
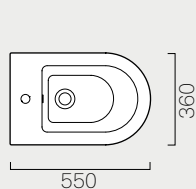
55

Description	Bidet
Code	8965111
Dimensions	55x36
Weight	Kg 16,4
Overflow	CL 25
Installation	wall-hung
Taphole	1

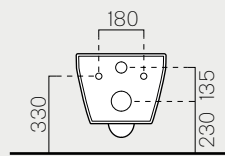
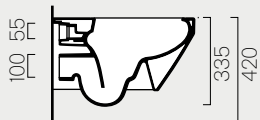
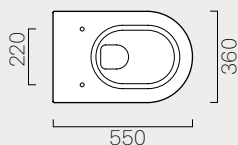
55/F

Description	Wc
Code	8915111
Dimensions	55x36
Weight	Kg 20,1
Flush system	swirlflush
Installation	wall-hung

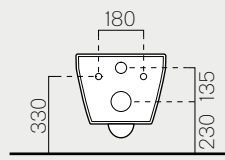
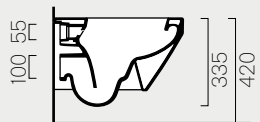
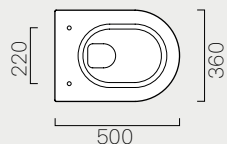
50

Description	Wc
Code	8918111
Dimensions	50x36
Weight	Kg 18,2
Flush system	standard
Installation	wall-hung

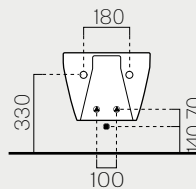
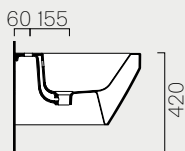
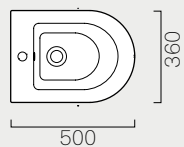
50

Description	Bidet
Code	8964111
Dimensions	50x36
Weight	Kg 16,2
Overflow	CL 25
Installation	wall-hung
Taphole	1

50/F

Description	Wc
Code	891611
Dimensions	50x36
Weight	Kg 20,2
Flush system	swirlflush
Installation	wall-hung

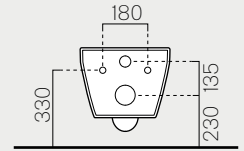
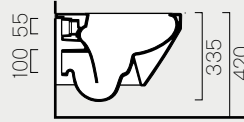
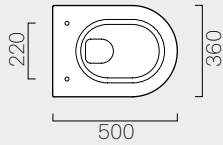

Vasca

Bathtub

Badewanne

179

Description	Bathtub
Code	VAT80
Dimensions	179x80 h60
Weight	Kg 64,7
Installation	freestanding
Material	acrylic

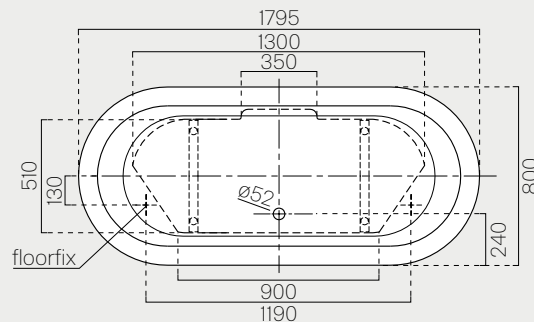
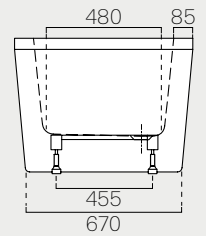
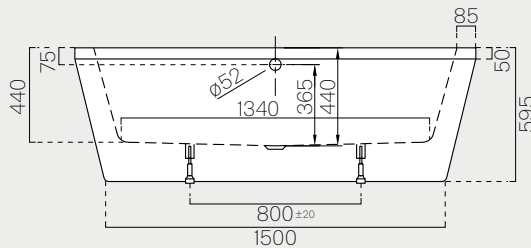

Disegni tecnici
Technical drawings
Technische
Zeichnungen

Pura

Lavabi

Washbasins

Waschbecken

Pura

120

Description	Washbasin
Code	8824111
Dimensions	120x50 h19
Weight	Kg 29,5
Capacity	Lt 17,5
Overflow	CL 25
Installation	wall-hung, built-in
Taphole	1(5)

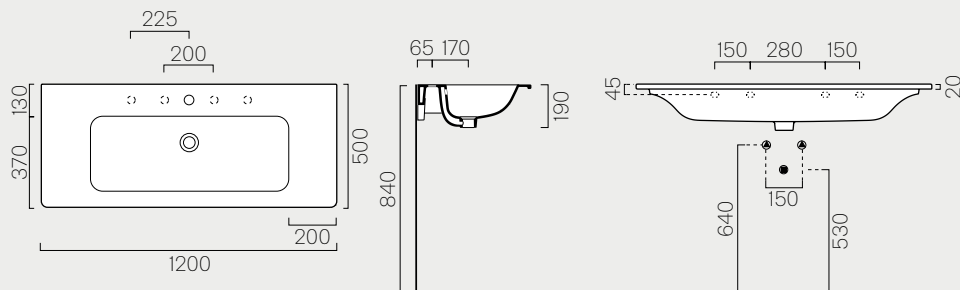

100

Description	Washbasin
Code	8823111
Dimensions	100x50 h19
Weight	Kg 23,2
Capacity	Lt 9
Overflow	CL 25
Installation	wall-hung, built-in
Taphole	1(3)

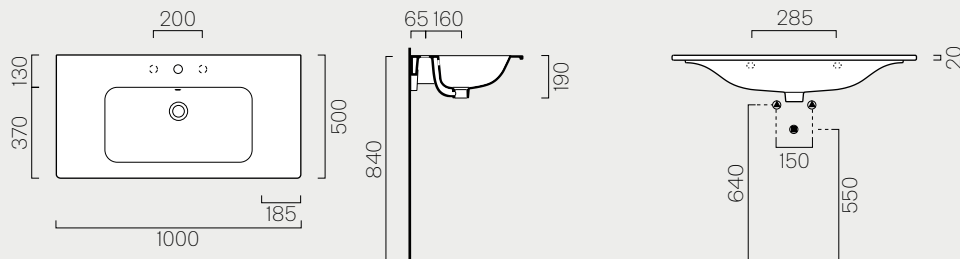

80

Description	Washbasin
Code	8822111
Dimensions	80x50 h19
Weight	Kg 17,8
Capacity	Lt 8,5
Overflow	CL 25
Installation	wall-hung, built-in
Taphole	1(3)

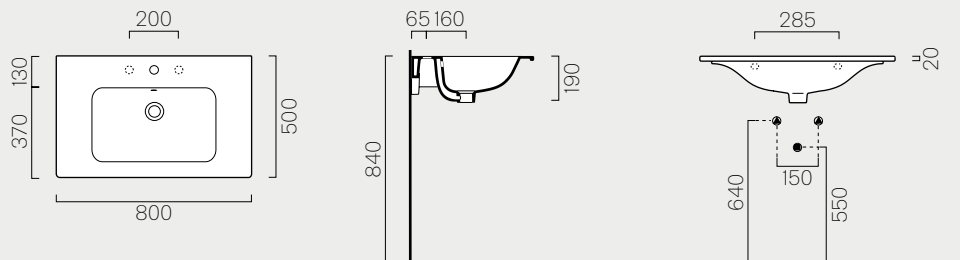

80/d

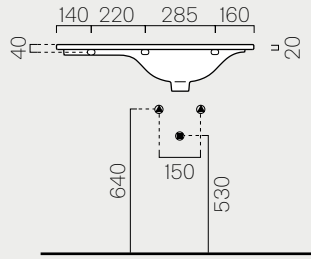
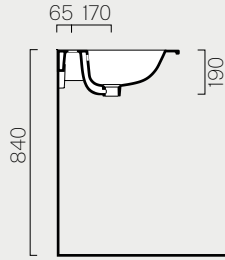
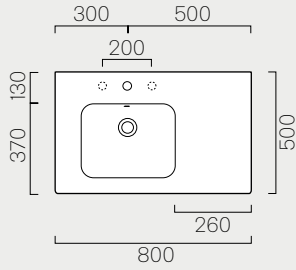

Description	Washbasin
Code	8856111
Dimensions	80x50 h19
Weight	Kg 18
Capacity	Lt 6,5
Overflow	CL 25
Installation	wall-hung, built-in
Taphole	1 (3)

Vista dal retro.
View from the back.
Blick von hinten.

80/s

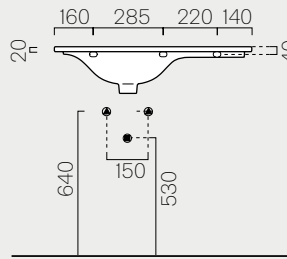
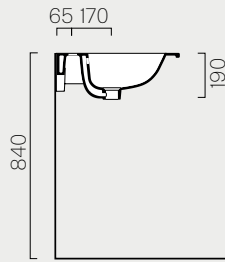
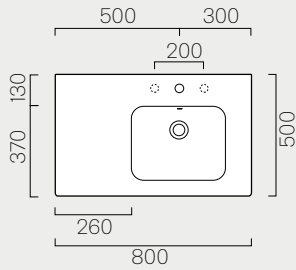

Description	Washbasin
Code	8857111
Dimensions	80x50 h19
Weight	Kg 18
Capacity	Lt 6,5
Overflow	CL 25
Installation	wall-hung, built-in
Taphole	1 (3)

Vista dal retro.
View from the back.
Blick von hinten.

60

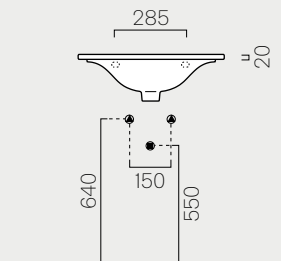
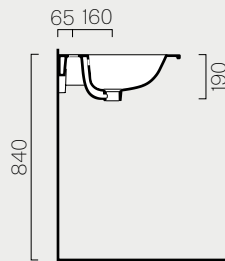
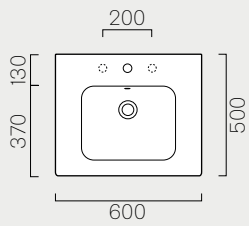

Description	Washbasin
Code	8831111
Dimensions	60x50 h19
Weight	Kg 14,8
Capacity	Lt 6
Overflow	CL 25
Installation	wall-hung, built-in
Taphole	1 (3)

102

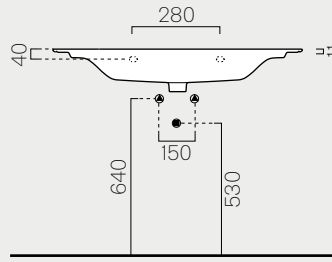
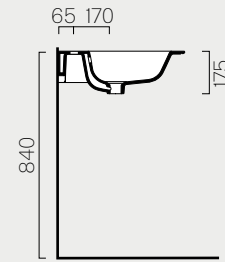
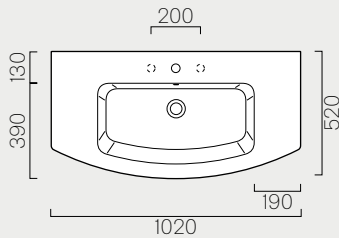

Description	Washbasin
Code	8825111
Dimensions	102x52 h19
Weight	Kg 21,2
Capacity	Lt 9,5
Overflow	CL 25
Installation	wall-hung, built-in
Taphole	1 (3)

82

Description	Washbasin
Code	8826111
Dimensions	82x49 h19
Overflow	CL 25
Installation	wall-hung, built-in
Taphole	1 (3)

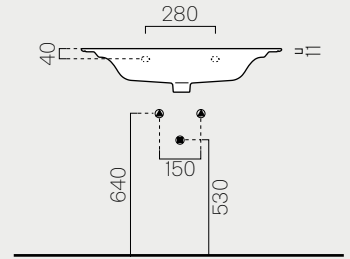
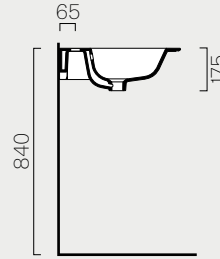
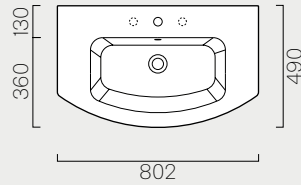

60/TI

Description	Washbasin
Code	883711
Dimensions	60x38 h14
Weight	Kg 12,5
Capacity	Lt 9
Overflow	CL 00
Installation	built-in, countertop
Taphole	0

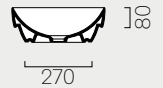
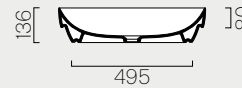
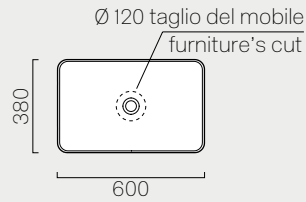

50/TI

Description	Washbasin
Code	884711
Dimensions	50x38 h14
Weight	Kg 10,5
Capacity	Lt 7
Overflow	CL 00
Installation	built-in, countertop
Taphole	0

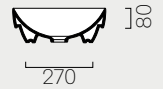
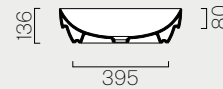
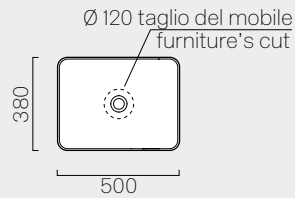

39/TI

Description	Washbasin
Code	884611
Dimensions	ø39 h14
Overflow	CL 00
Installation	built-in, countertop
Taphole	0

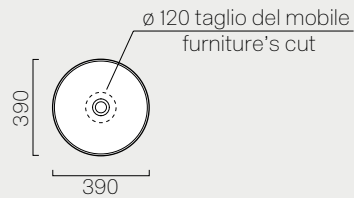

38/TI

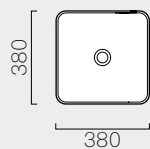

Description	Washbasin
Code	885011
Dimensions	38x38 h14
Weight	Kg 9
Capacity	Lt 5
Overflow	CL 00
Installation	built-in, countertop
Taphole	0

60/TS

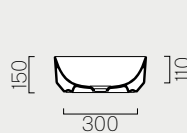
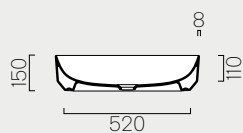
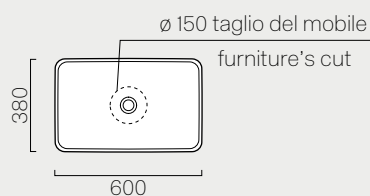

Description	Washbasin
Code	888311
Dimensions	60x38 h15
Weight	Kg 14,8
Capacity	Lt 12
Overflow	CL 00
Installation	countertop
Taphole	0

50/TS

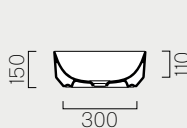
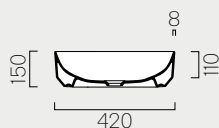
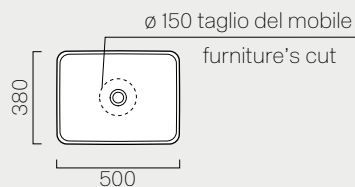

Description	Washbasin
Code	888211
Dimensions	50x38 h15
Weight	Kg 12,7
Capacity	Lt 9
Overflow	CL 00
Installation	countertop
Taphole	0

48/TS

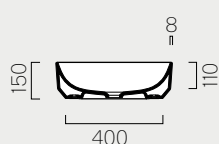
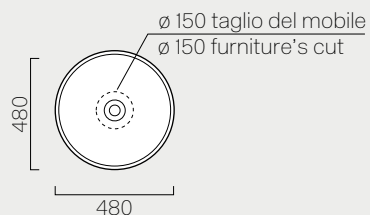

Description	Washbasin
Code	883511
Dimensions	ø48 h15
Weight	Kg 11,5
Capacity	Lt 10
Overflow	CL 00
Installation	countertop
Taphole	0

42/TS

Description	Washbasin
Code	882811
Dimensions	ø42 h15
Weight	Kg 9,2
Capacity	Lt 7
Overflow	CL 00
Installation	countertop
Taphole	0

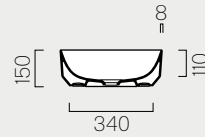
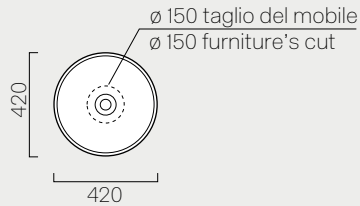

55/U

Description	Washbasin
Code	724311
Dimensions	55x38
Weight	Kg 8
Capacity	Lt 9,5
Overflow	CL 25
Installation	under-counter
Taphole	0

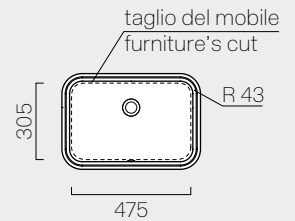
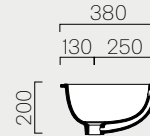
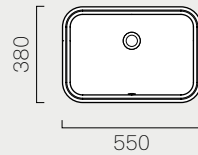

50/U

Description	Washbasin
Code	724711
Dimensions	50x35
Weight	Kg 7,6
Capacity	Lt 8
Overflow	CL 25
Installation	under-counter
Taphole	0

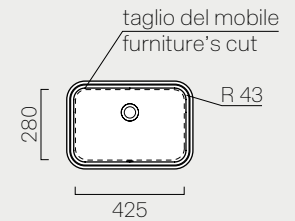
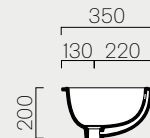
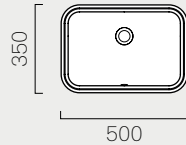

Wc e Bidet

Wc and Bidet

Wc und Bidet

55

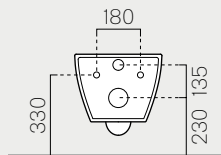
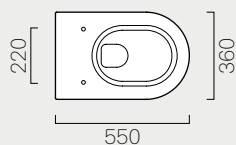

Description	Wc
Code	881211
Dimensions	55x36
Weight	Kg 23,7
Flush system	standard
Installation	wall-hung

55

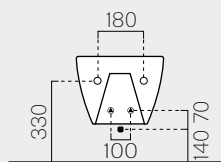
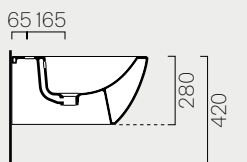
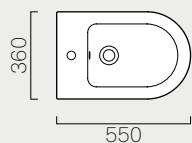

Description	Bidet
Code	8865111
Dimensions	55x36
Weight	Kg 17
Overflow	CL 25
Installation	wall-hung
Taphole	1

55/F

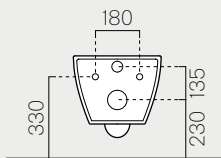
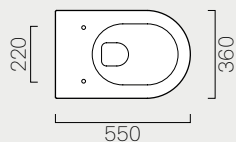

Description	Wc
Code	881511
Dimensions	55x36
Weight	Kg 18,5
Flush system	swirlflush
Installation	wall-hung

55/F

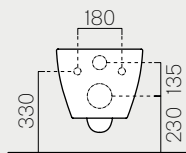
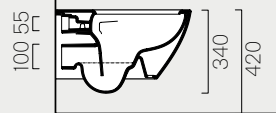
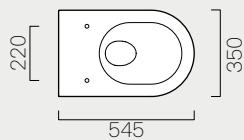

Description	Wc
Code	881111
Dimensions	54,5x35
Weight	Kg 23,3
Flush system	swirlflush
Installation	wall-hung

55

Description	Bidet
Code	8861111
Dimensions	54,5x35
Weight	Kg 17,1
Overflow	CL 25
Installation	wall-hung
Taphole	1

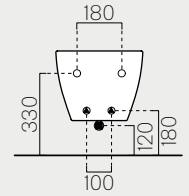
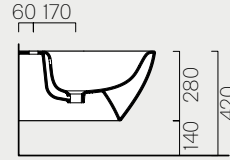
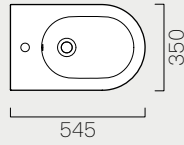

50

Description	Wc
Code	881811
Dimensions	50x36
Weight	Kg 18,5
Flush system	standard
Installation	wall-hung

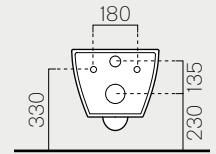
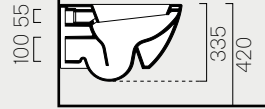
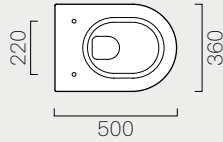

50

Description	Bidet
Code	8864111
Dimensions	50x36
Weight	Kg 16,3
Overflow	CL 25
Installation	wall-hung
Taphole	1

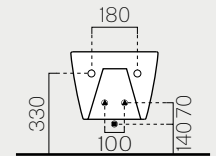
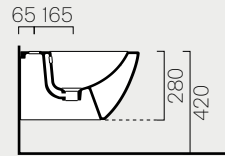
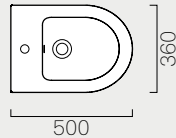

50/F

Description	Wc
Code	881611
Dimensions	50x36
Weight	Kg 22,8
Flush system	swirflush
Installation	wall-hung

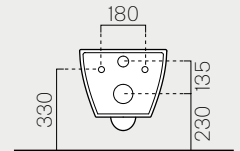
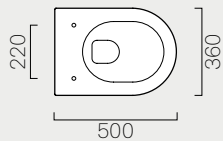

55

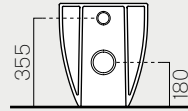
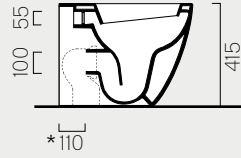
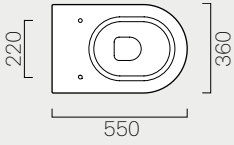

Description	Wc
Code	881411
Dimensions	55x36
Weight	Kg 24,5
Flush system	standard
Installation	floor standing

Curva tecnica
Technical curve



Codice Codes	MCURVA	MCURVAS	MCURVA90
Interasse Distance	* 110	* Da 160 a 185 mm * From 160 to 185 mm	* Da 55 a 75 mm * From 55 to 75 mm

55

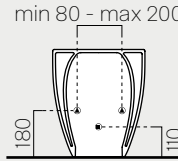
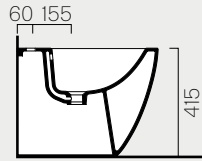
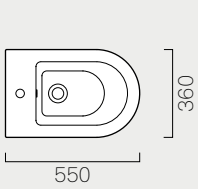

Description	Bidet
Code	8862111
Dimensions	55x36
Weight	Kg 23,1
Overflow	CL 25
Installation	floor standing
Taphole	1

55/F

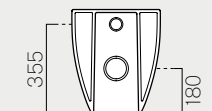
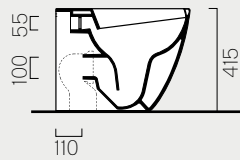
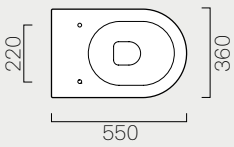

Description	Wc
Code	881911
Dimensions	55x36
Flush system	swirlflush
Installation	floor standing

50

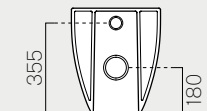
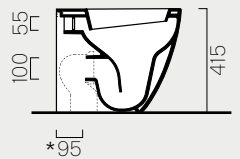
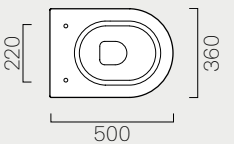

Description	Wc
Code	881911
Dimensions	50x36
Weight	Kg 23,5
Flush system	standard
Installation	floor standing

Curva tecnica
Technical curve



Codice Codes	MCURVA	MCURVAS	MCURVA90
Interasse Distance	* 95	* 165	* 70

50

Description	Bidet
Code	8869111
Dimensions	50x36
Weight	Kg 18
Overflow	CL 25
Installation	floor standing
Taphole	1

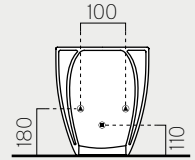
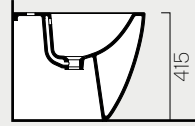
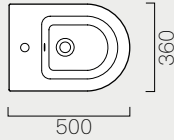

68

Description	Wc
Code	881711
Dimensions	68x36
Weight	Kg 33,3
Flush system	standard
Installation	floor standing

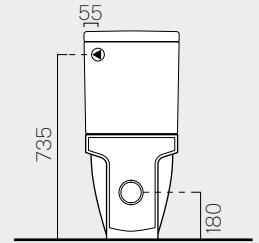
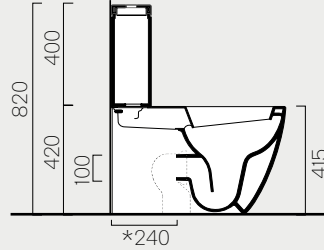
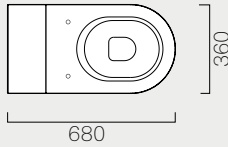

Curva tecnica
Technical curve



Codice
Codes

MCURVAS

MCURVA90

Interasse
Distance

* Da 230 a 305 mm
* From 230 to 305 mm

* Da 80 a 205 mm
* From 80 to 205 mm

Vista dal retro.
View from the back.
Blick von hinten.

Cassetta

Description	Cistern
Code	868111
Dimensions	17x31 43h
Weight	Kg 13,5

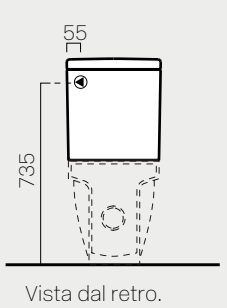
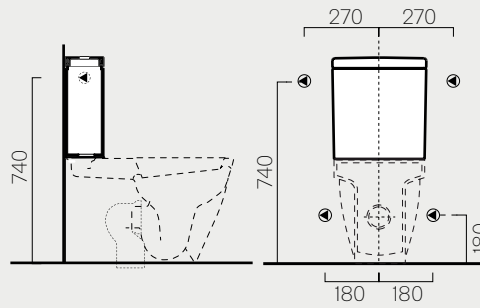
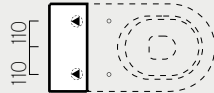

Vista dal retro.
View from the back.
Blick von hinten.

Scocca

Description	Ceramic Cover
Code	869111
Dimensions	13x35,5 46h
Weight	Kg 9,6

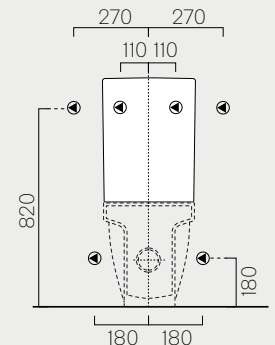
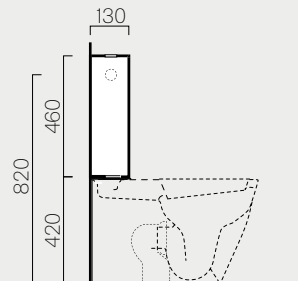

Vista dal retro.
View from the back.
Blick von hinten.

Orinatoio

Urinal

Urinal

39

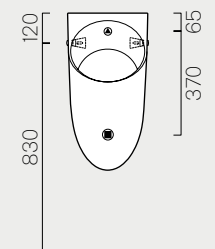
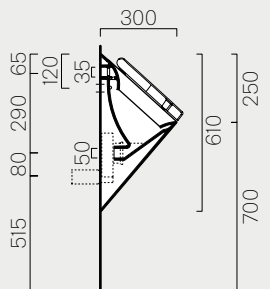
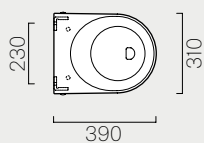

Description	Urinal
Code	769711
Dimensions	31x39 h60
Weight	Kg 12,4

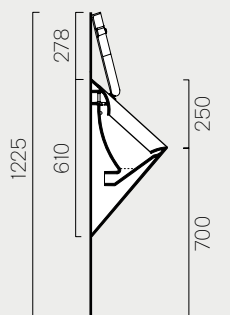
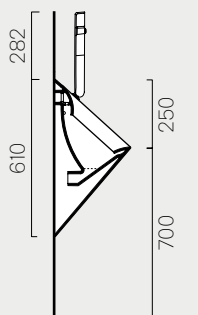

36

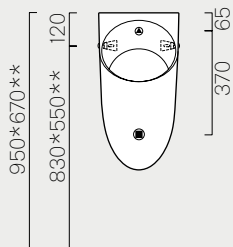
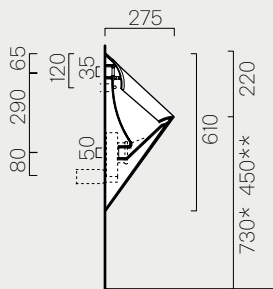
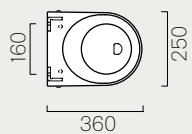

Description	Urinal
Code	889711
Dimensions	25x36 h60
Weight	Kg 9,8

* uomo/man
** bambino/kid

Vasca

Bathtub

Badewanne

Pura

190

Description	Bathtub
Code	VAPR90
Dimensions	190x90
Weight	Kg 53
Installation	freestanding
Material	acrylic

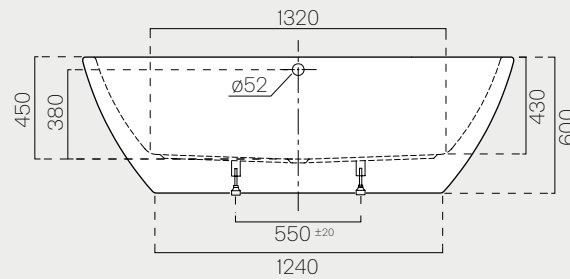
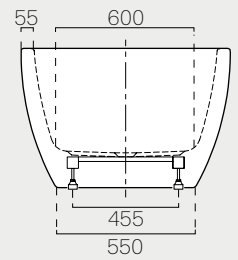
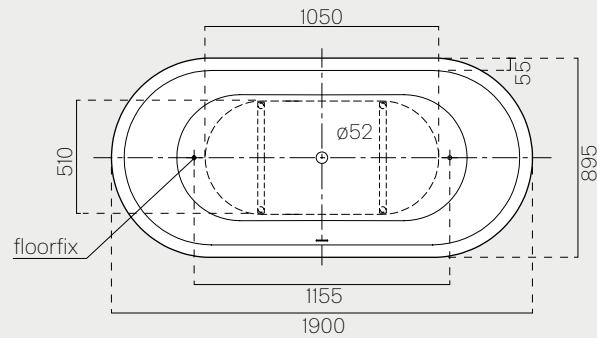

Disegni tecnici
Technical drawings
Technische
Zeichnungen

Modo

Lavabi

Washbasins

Waschbecken

Modo

120

Description	Washbasin
Code	7724111
Dimensions	120x50 h18
Weight	Kg 29
Capacity	Lt 11
Overflow	CL 25
Installation	wall-hung, built-in
Taphole	1(3)

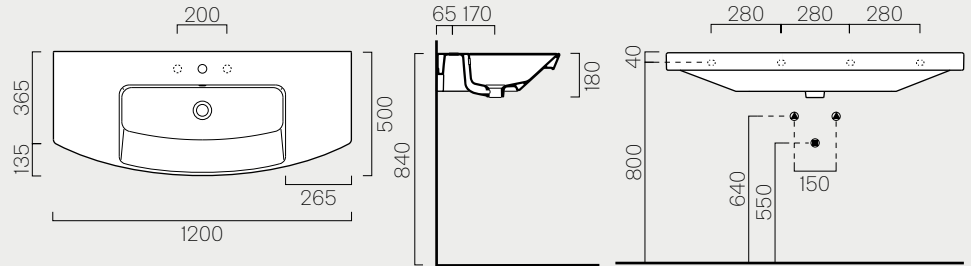

100

Description	Washbasin
Code	7723111
Dimensions	100x50 h18
Weight	Kg 24,6
Capacity	Lt 9,5
Overflow	CL 25
Installation	wall-hung, built-in
Taphole	1(3)

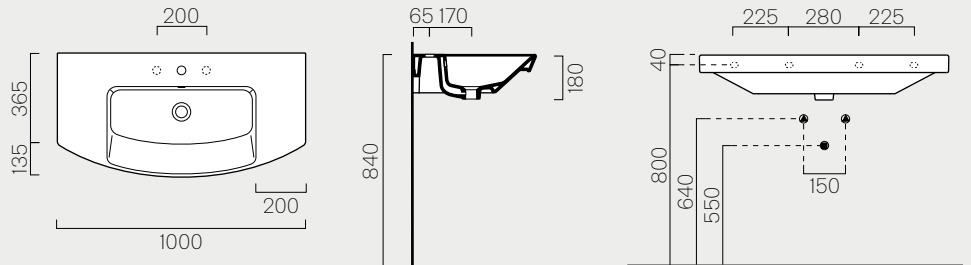

80

Description	Washbasin
Code	7722111
Dimensions	80x50 h18
Weight	Kg 21,1
Capacity	Lt 9
Overflow	CL 25
Installation	wall-hung, built-in
Taphole	1(3)

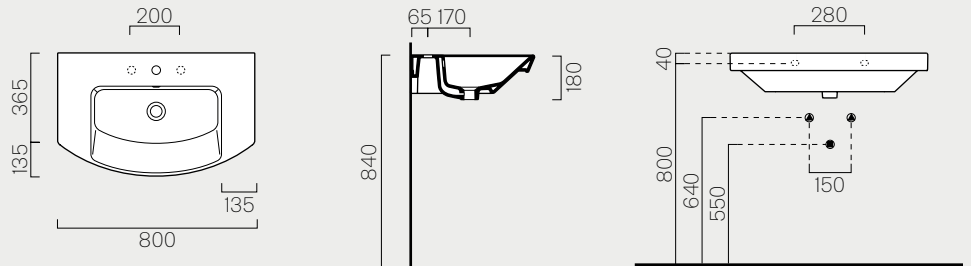

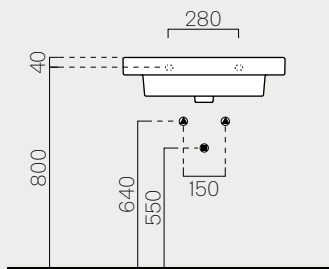
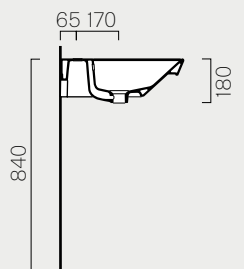
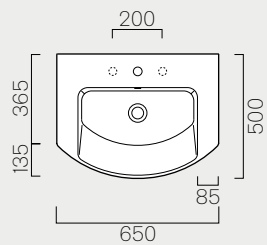
65

Description	Washbasin
Code	7732111
Dimensions	65x50 h18
Weight	Kg 20,1
Capacity	Lt 8,5
Overflow	CL 25
Installation	wall-hung, built-in
Taphole	1 (3)

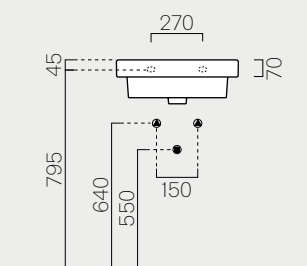
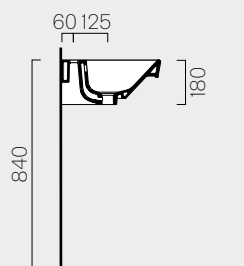
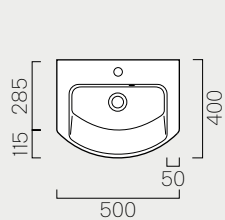
50

Description	Washbasin
Code	7785111
Dimensions	50x40 h18
Weight	Kg 11,4
Capacity	Lt 5
Overflow	CL 25
Installation	wall-hung, built-in
Taphole	1

Wc e Bidet

Wc and Bidet

Wc und Bidet

55

Description	Wc
Code	771211
Dimensions	55x38
Weight	Kg 22
Flush system	standard
Installation	wall-hung

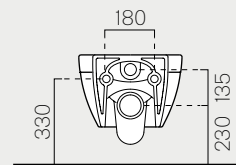
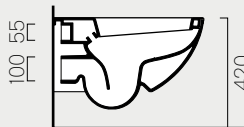
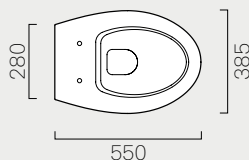

55

Description	Bidet
Code	771511
Dimensions	55x38
Weight	Kg 15,5
Overflow	CL 25
Installation	wall-hung
Taphole	1

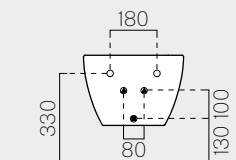
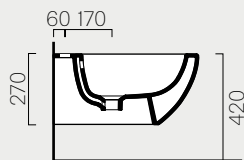
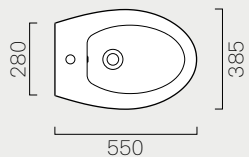

51

Description	Wc
Code	771011
Dimensions	51x38
Weight	Kg 21,1
Flush system	standard
Installation	wall-hung

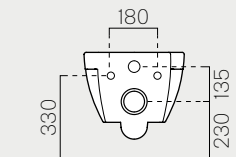
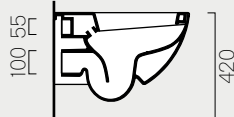
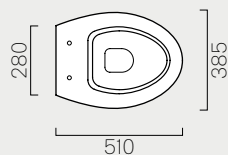

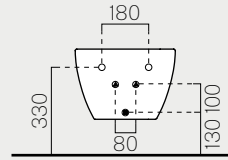
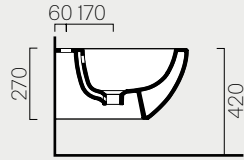
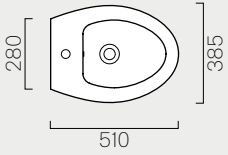

Description	Bidet
Code	7760111
Dimensions	51x38
Weight	Kg 15,9
Overflow	CL 25
Installation	wall-hung
Taphole	1

Vasca

Bathtub

Badewanne

Modo

190

Description	Bathtub
Code	VAM95
Dimensions	190x95
Weight	Kg 80
Installation	freestanding
Material	acrylic

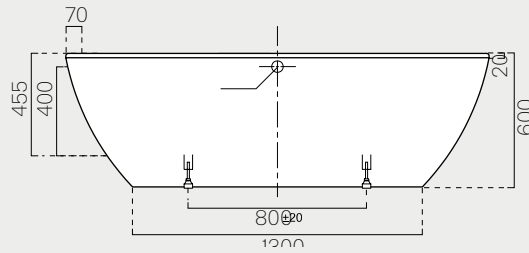
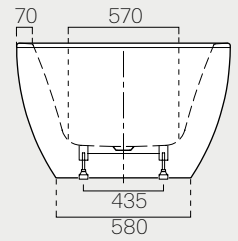
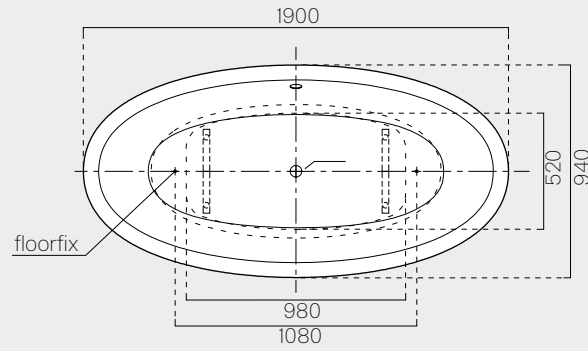

Disegni tecnici
Technical drawings
Technische
Zeichnungen

Classic

Lavabi

Washbasins

Waschbecken

Classic

125

Description	Washbasin
Code	8725111
Dimensions	125x54
Weight	Kg 42,1
Capacity	Lt 10
Overflow	CL 25
Installation	wall-hung, ceramic legs
Taphole	1(3)

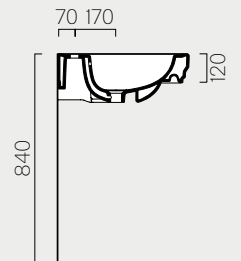
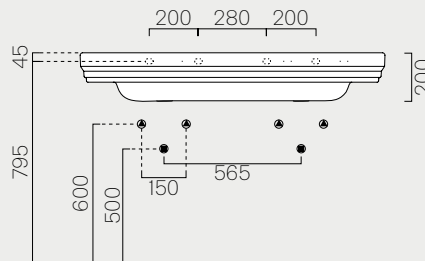
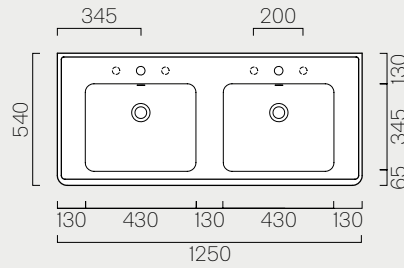

105

Description	Washbasin
Code	8723111
Dimensions	105x54
Weight	Kg 28
Capacity	Lt 12
Overflow	CL 25
Installation	wall-hung, ceramic legs, pedestal
Taphole	1(3)

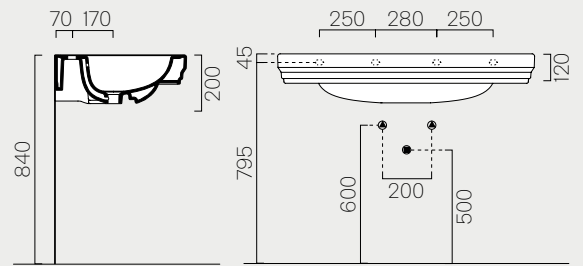
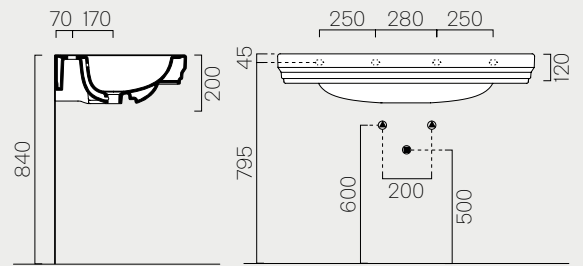
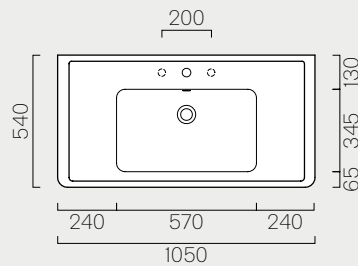

90

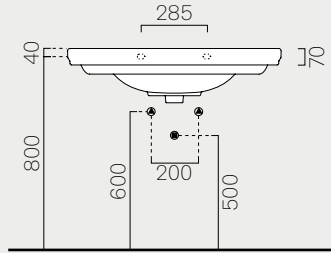
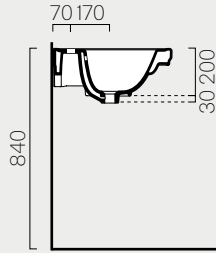
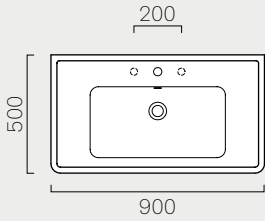

Description	Washbasin
Code	8788111
Dimensions	90x50
Weight	Kg 25,3
Capacity	Lt 10,5
Overflow	CL 25
Installation	wall-hung, pedestal
Taphole	1 (3)

75

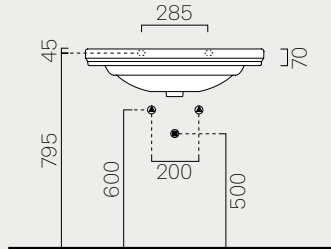
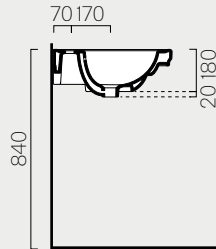
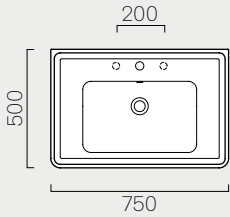

Description	Washbasin
Code	8787111
Dimensions	75x50
Weight	Kg 19,3
Capacity	Lt 6
Overflow	CL 25
Installation	wall-hung, pedestal
Taphole	1 (3)

60

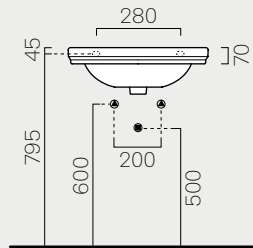
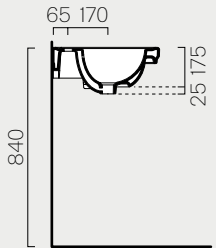
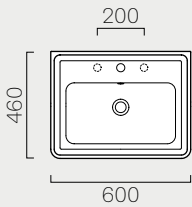

Description	Washbasin
Code	8781111
Dimensions	60x46
Weight	Kg 15,5
Capacity	Lt 5
Overflow	CL 25
Installation	wall-hung, pedestal
Taphole	1 (3)

Colonna

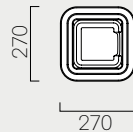
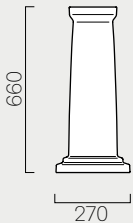

Description	Pedestal
Code	877011
Dimensions	66x27

60/T

Description	Washbasin
Code	874911
Dimensions	60x40
Weight	Kg 14,4
Capacity	Lt 8
Overflow	CL 25
Installation	countertop, built-in
Taphole	0

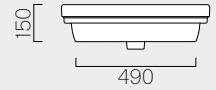
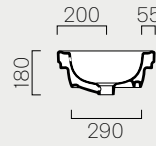
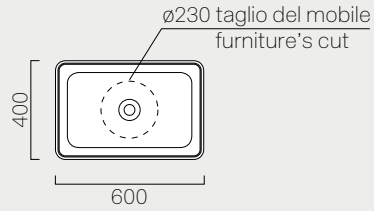

55/U

Description	Washbasin
Code	724311
Dimensions	55x38
Weight	Kg 8
Capacity	Lt 9,5
Overflow	CL 25
Installation	under-counter
Taphole	0

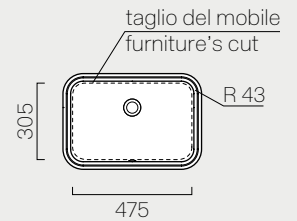
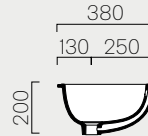
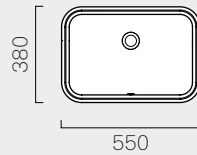

50/U

Description	Washbasin
Code	724711
Dimensions	50x35
Weight	Kg 7,6
Capacity	Lt 8
Overflow	CL 25
Installation	under-counter
Taphole	0

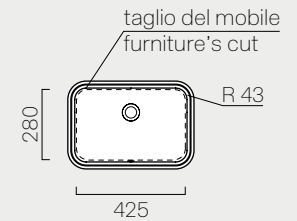
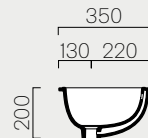
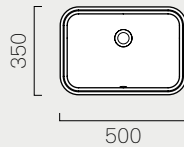

Wc e Bidet

Wc and Bidet

Wc und Bidet

55

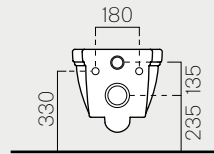
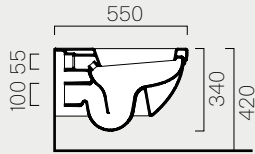
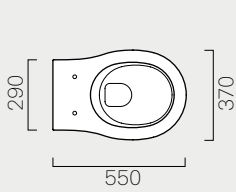

Description	Wc
Code	871211
Dimensions	55x37
Weight	Kg 20,5
Flush system	standard
Installation	wall-hung

55

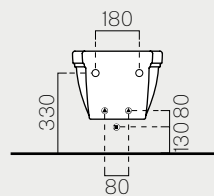
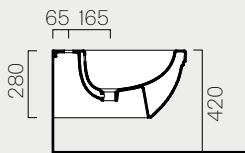
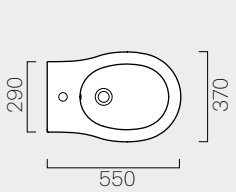

Description	Bidet
Code	8765111
Dimensions	55x37
Weight	Kg 17
Overflow	CL 25
Installation	wall-hung
Taphole	1

54

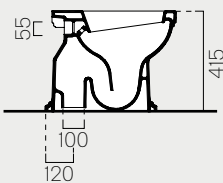
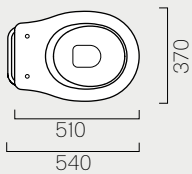

Description	Wc
Code	871011
Dimensions	54x37
Weight	Kg 22,5
Flush system	standard
Installation	floor standing

54

Description	Wc
Code	871111
Dimensions	54x37
Weight	Kg 22,5
Flush system	standard
Installation	floor standing

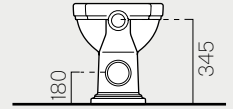
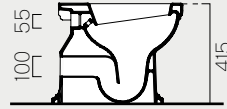
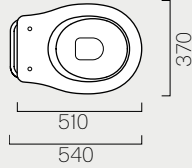

54

Description	Bidet
Code	8762111
Dimensions	54x37
Weight	Kg 18,2
Overflow	CL 25
Installation	floor standing
Taphole	1 (3)

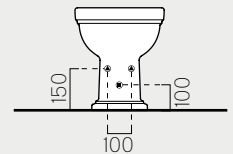
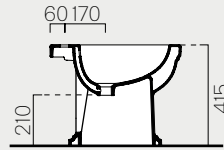
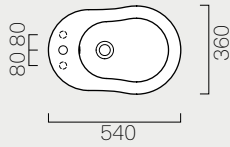

70

Description	Wc
Code	871711
Dimensions	70x37
Weight	Kg 25,2
Flush system	standard
Installation	floor standing

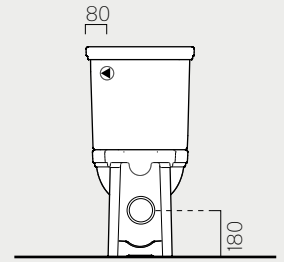
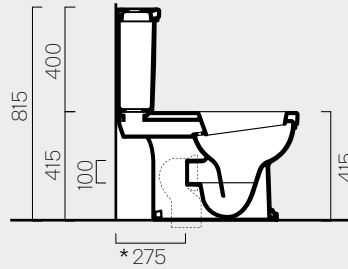
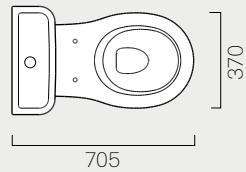

Curva tecnica
Technical curve

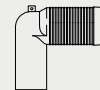

Codice
Codes

MCURVA

MCURVAS

MCURVA90

Interasse
Distance

* 275

* Da 250 a 320 mm
* From 250 to 320 mm

* Da 80 a 230 mm
* From 80 to 230 mm

Cassetta

Description	Cistern
Code	878111
Dimensions	17x42 h40
Weight	Kg 13,6

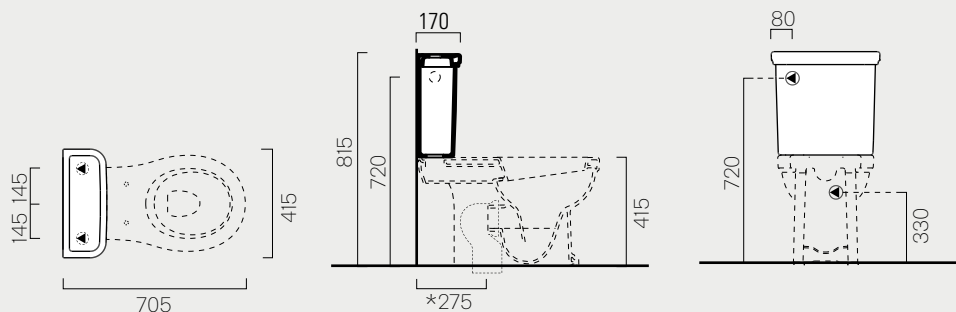

Cassetta

Description	Cistern
Code	879011
Dimensions	46x22 h41
Weight	Kg 16,5

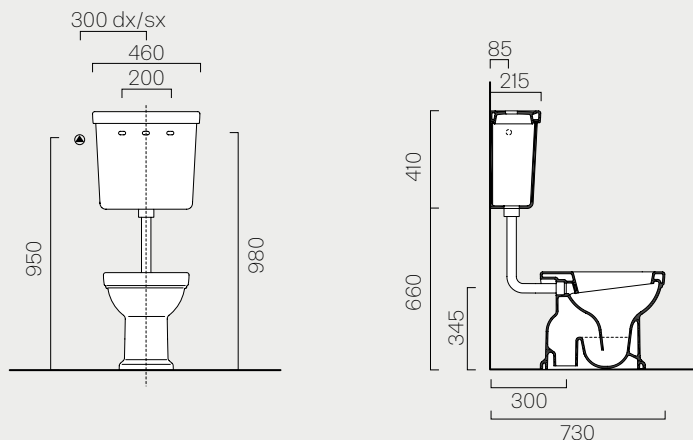

Cassetta

Description	Cistern
Code	878011
Dimensions	46x22 h41
Weight	Kg 16,5

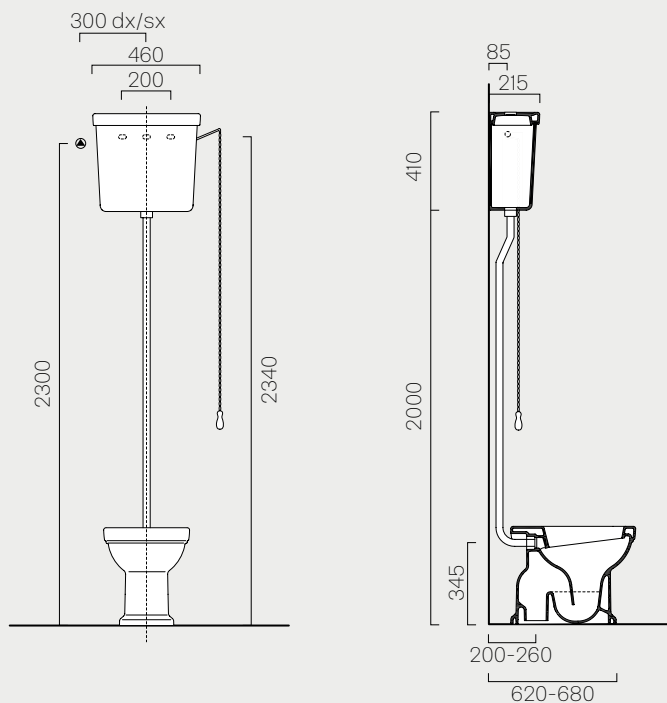

Vasca

Bathtub

Badewanne

Classic

175

Description	Bathtub
Code	VAL1
Dimensions	175x82 h84
Weight	Kg 65,3
Installation	freestanding
Material	acrylic

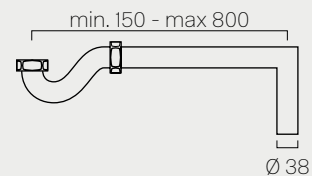
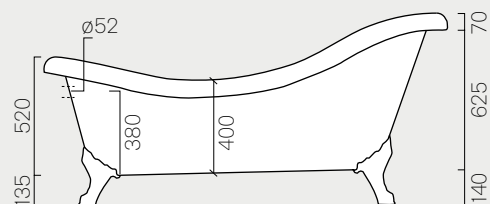

Description	Bathtub
Code	VAL2
Dimensions	175x82 h85
Weight	Kg 66,3
Installation	freestanding
Material	acrylic

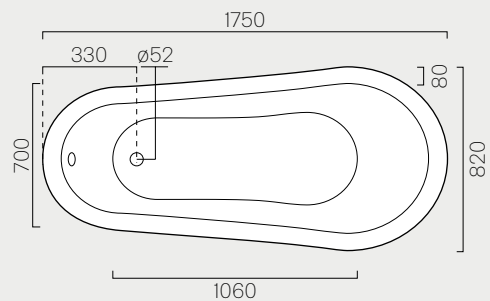

Disegni tecnici
Technical drawings
Technische
Zeichnungen

Community

Lavabi

Washbasins

Waschbecken

70

Description	Washbasin
Code	7631011
Dimensions	70X60 h16
Weight	Kg 21,8
Capacity	Lt 12
Overflow	CL 00
Installation	wall-hung,
Taphole	1(3)

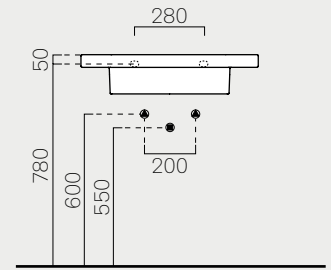
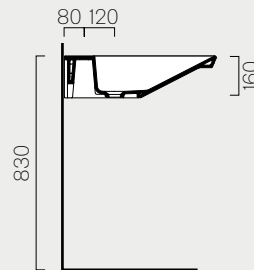
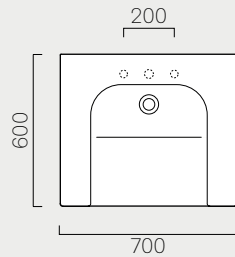

Wc e Bidet

Wc and Bidet

Wc und Bidet

70

Description	Wc
Code	761811
Dimensions	70x37
Weight	Kg 26,4
Flush system	standard
Installation	wall-hung

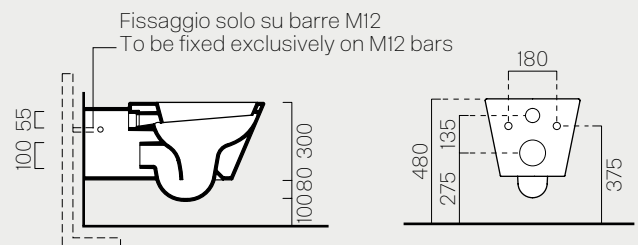
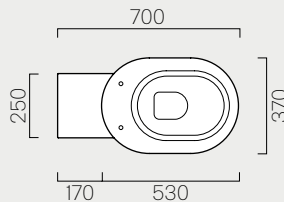

Orinatoio

Urinal

Urinal

39

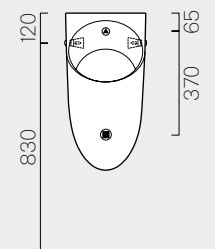
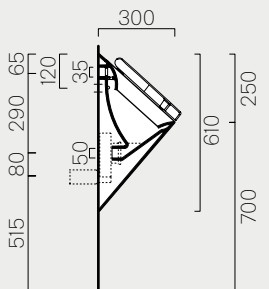
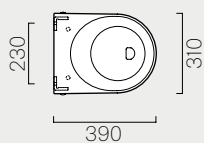

Description	Urinal
Code	769711
Dimensions	31x39 h60
Weight	Kg 12,4
Flush system	standard
Installation	wall-hung

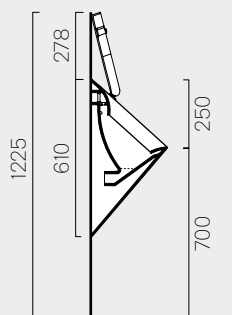
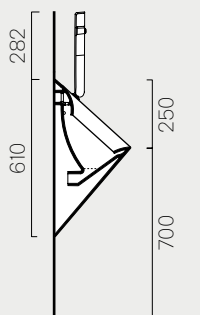

Piatti doccia H6

Shower trays H6

H6 Duschwannen

140

Description	Shower trays
Code	358711
Dimensions	140x80 h6
Weight	Kg 49,5
Installation	freestanding, flush-fitting
Material	ceramic

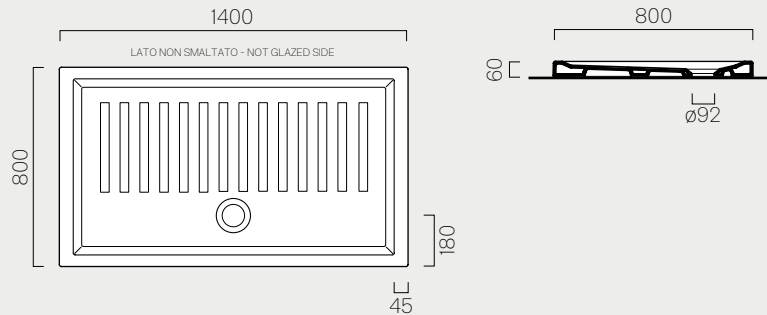

120

Description	Shower trays
Code	359811
Dimensions	120x80 h6
Weight	Kg 45,8
Installation	freestanding, flush-fitting
Material	ceramic

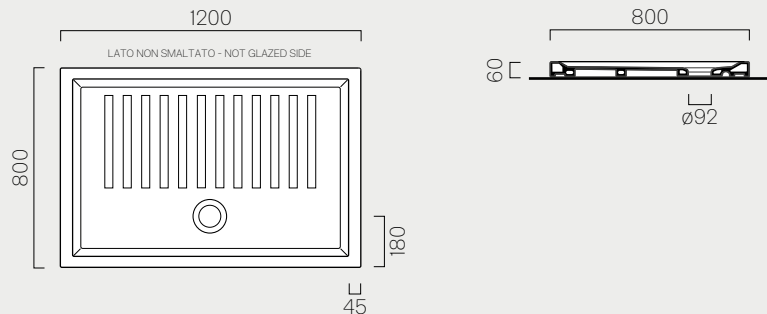

120

Description	Shower trays
Code	359911
Dimensions	120x70 h6
Weight	Kg 40,3
Installation	freestanding, flush-fitting
Material	ceramic

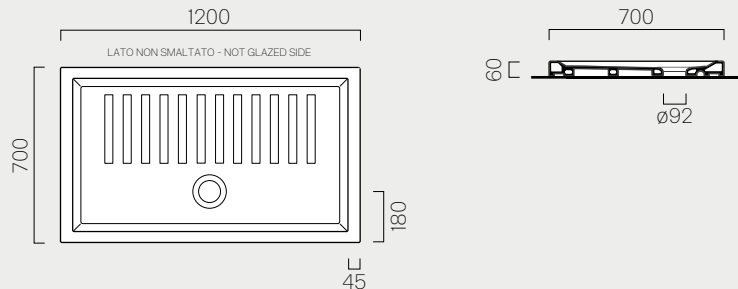

100

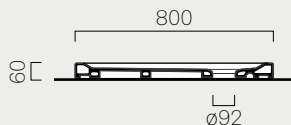
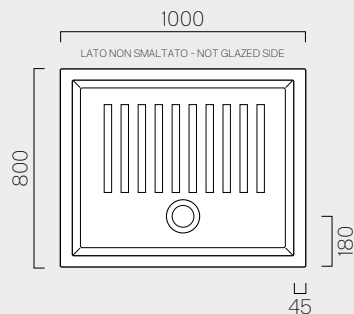

Description	Shower trays
Code	358611
Dimensions	100x80 h6
Weight	Kg 38,5
Installation	freestanding, flush-fitting
Material	ceramic

100

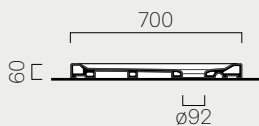
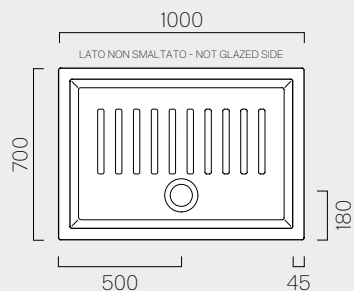

Description	Shower trays
Code	358911
Dimensions	100x70 h6
Weight	Kg 33,7
Installation	freestanding, flush-fitting
Material	ceramic

90

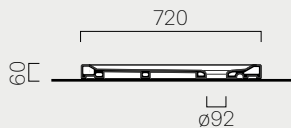
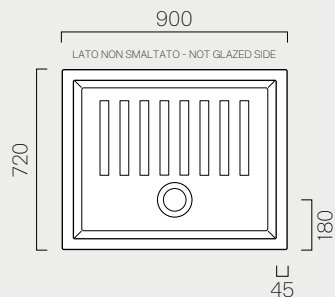

Description	Shower trays
Code	359711
Dimensions	90x72 h6
Weight	Kg 31,5
Installation	freestanding, flush-fitting
Material	ceramic

90/a

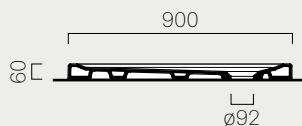
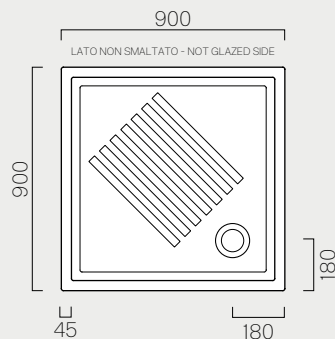

Description	Shower trays
Code	339711
Dimensions	90x90 h6
Weight	Kg 35,9
Installation	freestanding, flush-fitting
Material	ceramic

80/α

Description	Shower trays
Code	338611
Dimensions	80x80 h6
Weight	Kg 31,1
Installation	freestanding, flush-fitting
Material	ceramic

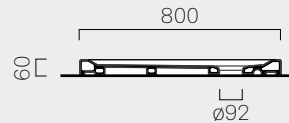
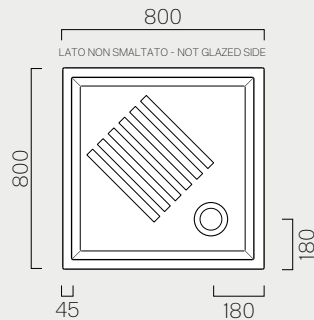

90

Description	Shower trays
Code	349711
Dimensions	90x90 h6
Weight	Kg 31,3
Installation	freestanding, flush-fitting
Material	ceramic

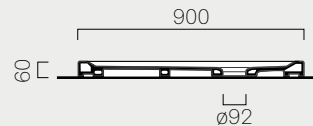
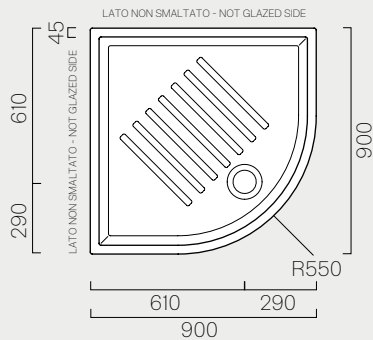

80

Description	Shower trays
Code	348611
Dimensions	80x80h6
Weight	Kg 26
Installation	freestanding, flush-fitting
Material	ceramic

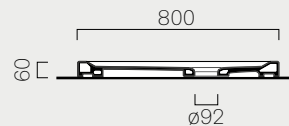
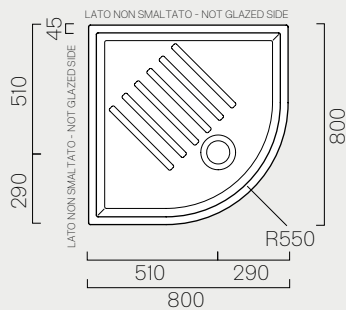

Italian Made

I prodotti presenti in questo volume sono progettati e realizzati in Italia secondo i più alti standard qualitativi, nella tutela dell'ambiente, dei diritti e della salute dei lavoratori.

The products in this catalog are designed and produced in Italy according to the highest quality standards, the environmental protection and ofcourse according to the rights and health of employees.

Die Produkte in diesem Katalog wurden in Italien unter Achtung der höchsten Qualitätsanforderungen, des Umweltschutzes und selbstverständlich der Rechte und der Gesundheit der Mitarbeiter entworfen und hergestellt.

Art Direction/Layout
Studio CCRZ

Photography
Studio Ciapetti

Styling
Monti Studio

Coordination
GSI Lab

Printed by
Intese Grafiche

Thanks to
cc tapis
rugstar
bloc studio
living divani
luceplan
catellani & smith
desalto
il giardino di legno
fioroni
moroso
zanotta
scarazzini
cristina rubinetterie

Le immagini e i dati contenuti nel presente catalogo sono da ritenersi indicativi e possono subire variazioni anche senza alcun preavviso.

Images and data contained in this catalogue are to be considered indicative and may be changed also without any notice.

Die in diesem Katalog enthaltenen Bilder und Daten gelten als hinweisend und können jederzeit geändert werden.

stampato 4/17
printed 4/17
gedruckt 4/17

GSI

S.p.a. Strada Provinciale 150, km 3,125
01035 Gallese (VT), Italia
T +39 07614911
F +39 0761496111
www.gsiceramica.it

