

D[®] DESIGN ITALY
GD[®] GLASS DESIGN ITALY
GD[®] GLASS DESIGN ITALY
GD[®] GLASS DESIGN ITALY
G[®] GLASS

D[®] DESIGN ITALY
GD[®] GLASS DESIGN ITALY
GD[®] GLASS DESIGN ITALY
GD[®] GLASS DESIGN ITALY
G[®] GLASS

D[®] DESIGN ITALY
GD[®] GLASS DESIGN ITALY
GD[®] GLASS DESIGN ITALY
GD[®] GLASS DESIGN ITALY
G[®] GLASS

D[®] DESIGN ITALY
GD[®] GLASS DESIGN ITALY
GD[®] GLASS DESIGN ITALY
GD[®] GLASS DESIGN ITALY
G[®] GLASS

D[®] DESIGN ITALY
GD[®] GLASS DESIGN ITALY
GD[®] GLASS DESIGN ITALY
GD[®] GLASS DESIGN ITALY
G[®] GLASS

D[®] DESIGN ITALY
GD[®] GLASS DESIGN ITALY
GD[®] GLASS DESIGN ITALY
GD[®] GLASS DESIGN ITALY
G[®] GLASS

D[®] DESIGN ITALY
GD[®] GLASS DESIGN ITALY
GD[®] GLASS DESIGN ITALY
GD[®] GLASS DESIGN ITALY
G[®] GLASS

GD[®]
GLASS DESIGN ITALY

Percorsi Privileged
privilegiati paths
dell'of
acqua water



Glass Design è un'eccellenza Italiana nella produzione e nel design di lavabi e complementi d'arredo bagno. ***Glass Design** is an Italian excellence in the production and design of bathroom washbasins and interior decoration furnishings.*

Situata a Vinci, cuore della Toscana e città di "Leonardo da Vinci", Glass Design è stata fondata nel 1984 dalla famiglia Borsellini, dopo una pluriennale esperienza nella manifattura del vetro artistico.

Located in Vinci, in the heart of Tuscany and native town of "Leonardo da Vinci", Glass Design was founded in 1984 by the Borsellini family, further to a long tradition in manufacturing artistic glass.

Utilizzando materiali tecnologicamente avanzati, come il Silicio o l'Inox e, lavorando ad arte su materiali tradizionali, come il cristallo molato o il vetro artistico, Glass Design contribuisce alla creazione di un nuovo stile dove l'accessorio, curato nei minimi dettagli, diventa il soggetto principale dell'ambiente, un vero prodotto "moda", apprezzato nel mondo ed esportato in più di 60 paesi.

Both by using technologically advanced materials such as stainless steel or silicone, and by working in an artistic way with traditional materials like the formed 24%pb crystal and the artisan glass, the company Glass Design contributes to the creation of a new style, where even the accessory is addressed in all details, becoming the main subject of the environment, a true "fashion" product, highly appreciated in the world and exported to more than 60 countries.

Oltre 200 artigiani Toscani e una quindicina di vetrai muranesi appartengono alla filiera produttiva aziendale, permettendo di adattare ogni prodotto ad esigenze e richieste specifiche del cliente, con infinite personalizzazioni realizzando così, prodotti unici ed esclusivi.

Over 200 Tuscan artisans and more than 15 glassmakers of Murano work within the company's production chain, enabling the customization of each product to suit individual needs and specific requirements, in order to create unique and exclusive products.

Indice

Index



Kool
12



Air
20



Morpheo
22

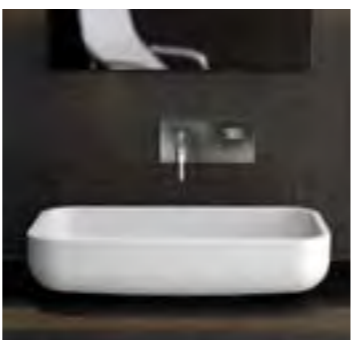

Jimmy
24



Net
26



Stone
28



FLower
32



Rho
36



Four
45



Blade
52



Infinity Colour
54



Infinity Starlight
56



Open
58



Cocoon
62



Cocoon Lux
64

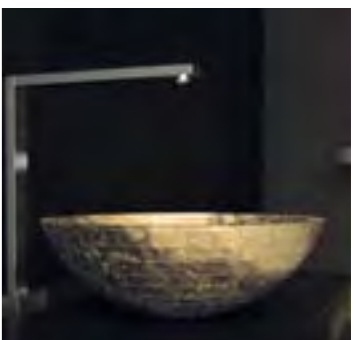

Mosaic
66

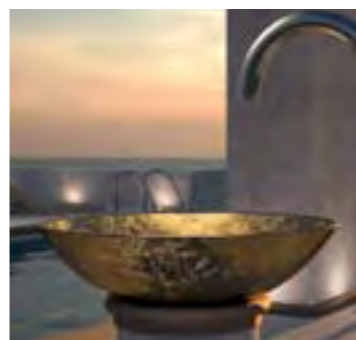

Circus 50
68



Circus 43
70



Oval
73

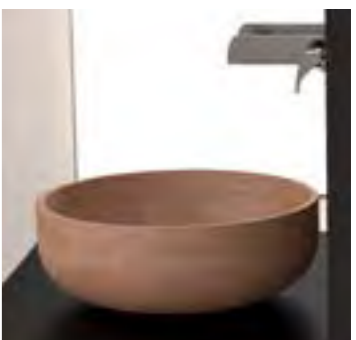

Rapolano
74



Modo
76



Yacht
77



Roma
78



Exté Lux
82

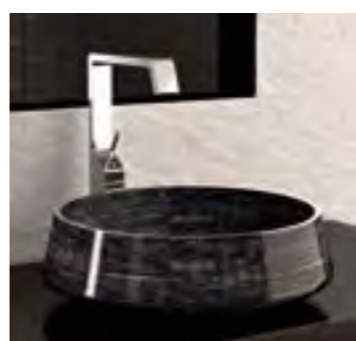

Exté
84



Nek Lux
86



Nek
88



Ares
90



Round
92



Vogue
94



Calla
98



Laguna
Vintage
104



Moon
132



Chelo
134

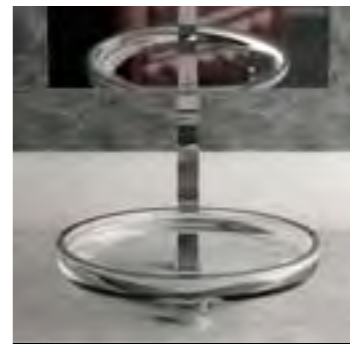

Clivia
136



Marinus
138



Laguna
Rossa
105



Laguna
106



Canale
112



Ottico
113



Ramada
139



Aqua
140



Moon
Over Ice
142



Glo Ball
Crystal Ice
144



Gondola
114



Carnival
116



Gondola
Spring
118



Glo Ball
Murano
120



Glo Ball
Crystal Ramada
146



Venice
150



Graffiti
152



Luna
154



Collier
124



Ice Oval
126



Ice Oval Lux
128

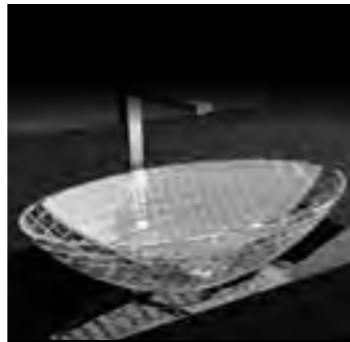

Luxor Oval
130



Luna Katino
156



Luna Forma
157

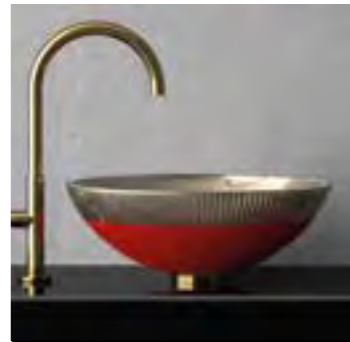

Filigrana
158



Flare Tech
159



Flare
160



Kalahari
162



Xeny
164



Flou
166



Glo Ball
158



De Coste
160



Barchetta Light
194



Barchetta
195



Soffio
168



Tekno Materic
170

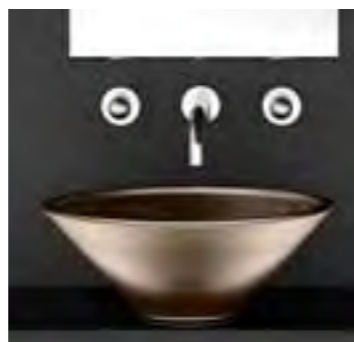

Tekno Metal
172



Tekno Lux
174



Gum
166

Accessori
accessories
198

Specifiche
data sheet
210

Materiali
materials
268



Filò Katino
176



Bamboo Katino
178



Oasy
179



Perla
180



Onda
181



Globo
182



Loop
183



Mito
156

Benvenuti nel mondo della "creatività"
Welcome to the "creativity" world

Vetro Freddo®

L' esaltazione della materia attraverso l'anima del suo colore.
A unique material. Expressive colours.

Il Vetro Freddo® è un materiale innovativo, composto da pigmenti vetrosi e resine. La sua caratteristica principale è la sua versatilità nell'adattarsi a qualsiasi tipo di forma. E' l'esaltazione della materia che si esprime attraverso l'anima del suo colore. La natura della sua materia, composta da pigmenti vetrosi e pertanto trasparenti, permette al VetroFreddo® di avere uno dei suoi principali punti di forza, e cioè la possibilità di esprimersi in colori trasparenti, traslucidi od opachi. Nessun limite quindi a livello cromatico e, oltre alla gamma di colori già esistente, è possibile scegliere in base alle proprie esigenze, uno dei numerosi colori presenti nella mazzetta "RAL". Il VetroFreddo® ha una resistenza termica di circa 100°C e può essere lavorato con gli stessi utensili del marmo o del vetro. Tutti gli oggetti in VetroFreddo® si possono lavare con qualsiasi tipo di sapone o detergente neutro non granulare, usando panni o spugne non abrasive. In caso di graffi superficiali, si può ripristinare l'oggetto intervenendo con un panno imbevuto di olio d'oliva o una semplice crema per le mani. In caso di graffi più profondi, è possibile ripristinare con una speciale carta vetro suggerita dal produttore in base al colore o al tipo di oggetto.

VetroFreddo® is an innovative material composed of glass pigments and resin. Its major characteristics are its versatility in adapting itself to any form or shape imaginable. The material's unique characteristics are expressed through the soul of its colour, which can be in clear, semi-transparent or opaque form, due to the material composition of glass pigments. No limits exist in regards to colour. Apart from the existing range of colours, any colour from the "RAL" colour scheme can be chosen. VetroFreddo® is temperature resistant up to approximately 100°C and can be worked with and carved just as marble or glass. All objects designed with the material VetroFreddo® can be cleaned with any type of non-granular soap, using soft sponges or tissues. In case of superficial damage (scratches), the damaged area should gently be rubbed with a sheet soaked in olive oil. In case of deeper scratches or damage, a special replacement glass paper is available from the manufacturer for every colour and type of object.

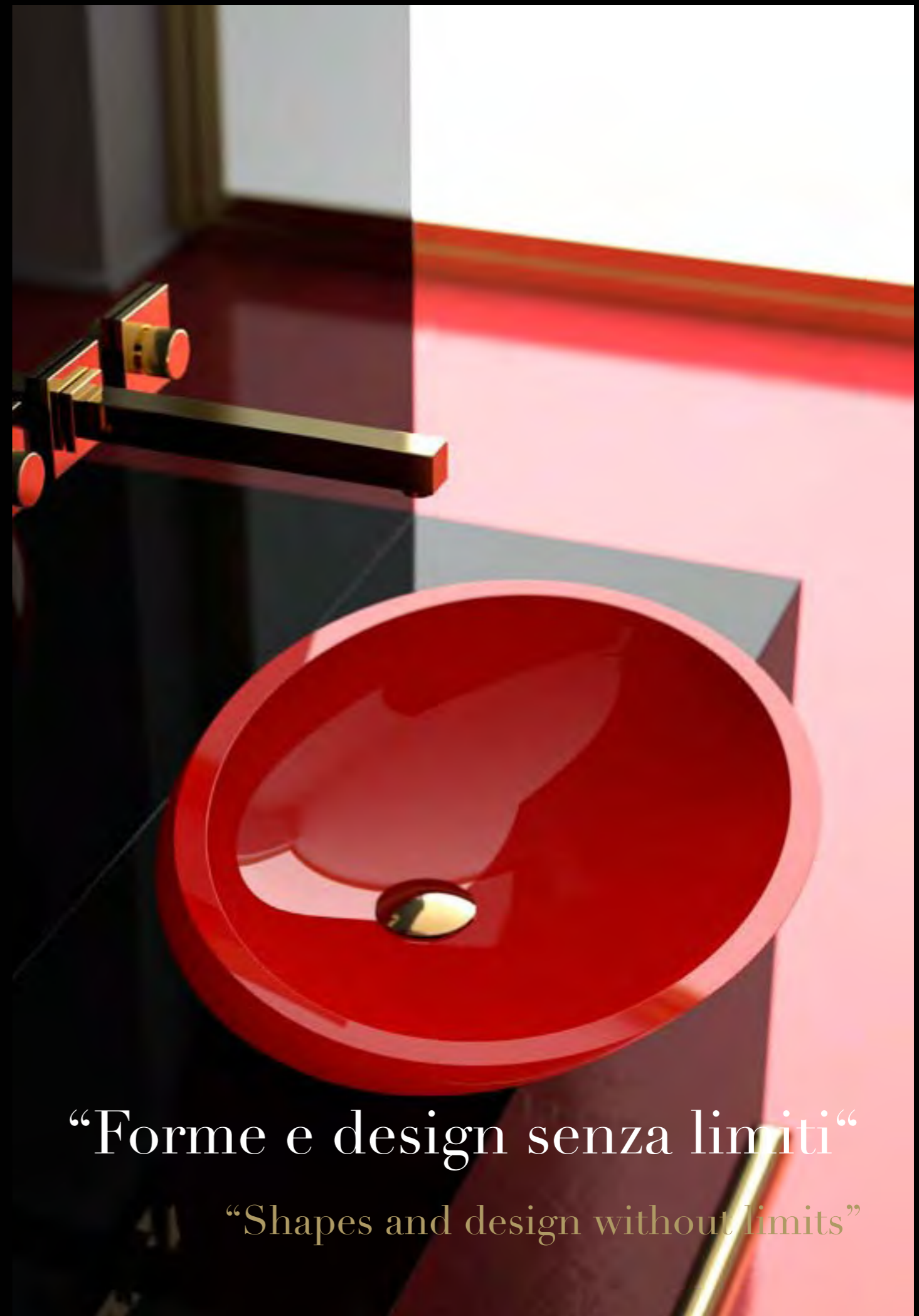

“Forme e design senza limiti”

“Shapes and design without limits”

Kool

Vetro Freddo®



KOOL code KOOLT034

brevettato / patented



KOOL code KOOLT034

brevettato / patented

13



KOOL MAX code KOOLMAXT035

brevettato / patented





VetroFreddo®



KOOL MAX code KOOLMAXPO30

brevettato / patented



KOOL XL code KOOLXLPO01

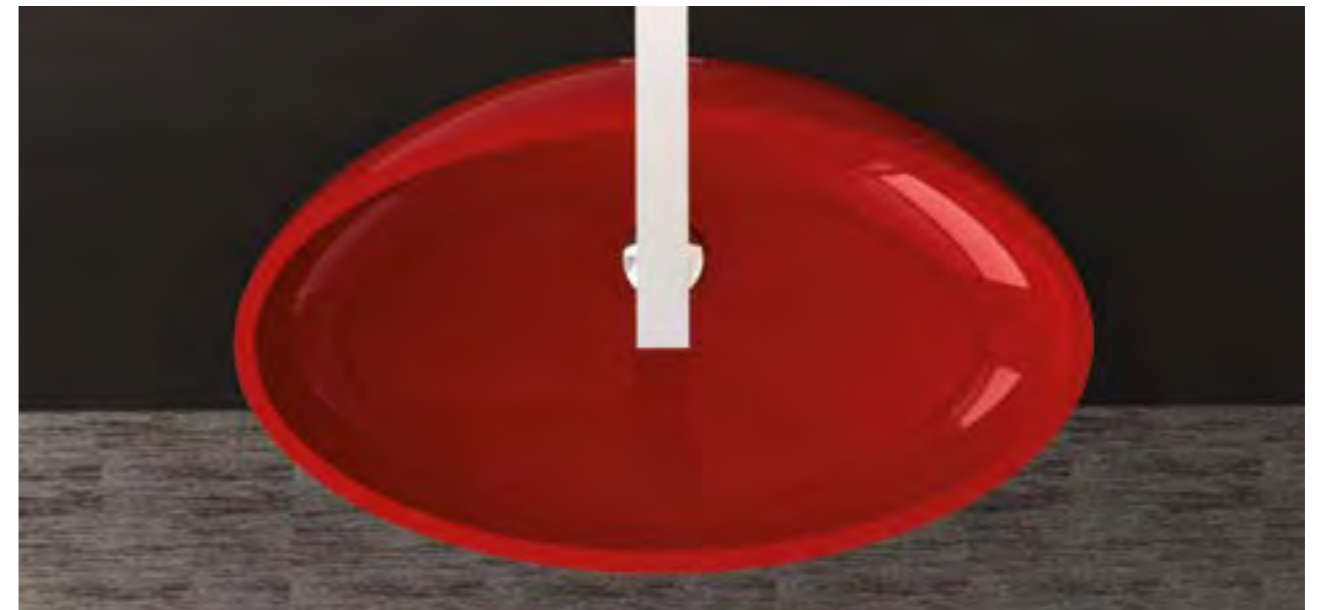

KOOL XL code KOOLXLPL34 Ferrari red

brevettato / patented



Kool

Vetro Freddo



KOOL MAX code KOOLMAXFO

brevettato / patented



KOOL MAX code KOOLMAXFA

brevettato / patented



Kool Oversize

VetroFreddo®



brevettato / patented

KOOL OVERSIZE code KOOLOVERPO30



KOOL OVERSIZE code KOOLOVERPO1



KOOL OVERSIZE code KOOLOVERPL34 Ferrari red

brevettato / patented



Air

Vetro Freddo®



brevettato / patented

AIR code AIRPO30



brevettato / patented

AIR code AIRPO01



Morpheo

Max

Vetro Freddo®



Lunardi Menchini
DESIGN

MORPHEO MAX code MOMAXPO01



MORPHEO MAX code MOMAXPO01



Jimmy

Vetro Freddo®



JIMMY code JIMMYPO01



JIMMY code JIMMYPO30



JIMMY code JIMMYTO35

Net

Vetro Freddo®



NET code NETPO30



NET code NETPO01



NET code NETTO34



Stone

VetroFreddo®



Pert[®]
polimero tecnologico

Leggerezza e design sposano la tecnologia.
Light weight, spectacular design, innovative technology.

Il Pert[®] è un polimero tecnologico dalle qualità eccezionali, che unisce un basso peso specifico ad un'elevata resistenza meccanica. Particolarmente adatto in quei settori dove l'esigenza della leggerezza del peso è fondamentale (nautico, aereo, camper...). E' un materiale che permette la realizzazione di prodotti di elevato design, eseguiti a regola d'arte, rispettando angoli, raggi, bassorilievi e planarità con la possibilità di scelta tra una vasta gamma di colori, personalizzabili a richiesta.

Pert[®] is a technological polymer of extraordinary quality, combining a low specific weight with high mechanical resistance. It is particularly suited to fields where light weight is essential (e.g. in nautical, aeronautical, camping, etc).

It is a material which enables the creation of products of high design, finely made, allowing perfectly crafted angles and a smoothly plane surface, with the possibility of choosing among a wide range of colours to suit individual demand.

“Collezione d'arte futurista”

“The avant-garde collection”



FLower

design by: **Marco Pisati**

Pert®



FLOWER code FLOPL34 Ferrari red



brevettato / patented

32

33

FLower

design by: **Marco Pisati**

Pert[®]



FLOWER code **FLO402**

brevettato / patented



FLOWER code **FLO401**

brevettato / patented



Rho
Metal

Pert



RHO METAL code RHOGD



RHO METAL code RHOPL



Rho
Starlight

Pert®



RHO STARLIGHT code RHOLH05

38



RHO STARLIGHT code RHOLH01



RHO STARLIGHT code RHOLH43

39



Rho
Lux
Pert®



RHO LUX code RHOFO
Console MUSA - DA VINCI Collection



RHO LUX code RHOFA



Rho
Vision

Pert[®]



RHO VISION code RHONO



Rho
Lux
Pert®



RHO LUX code RHOFO
ROUND mirror - DA VINCI Collection
Console MUSA - DA VINCI Collection

Four
Lux
Pert®



FOUR LUX code FOURFA
ROUND mirror - DA VINCI Collection
Console MUSA - DA VINCI Collection



Four
Lux

Pert®



46

FOUR LUX code FOURFO

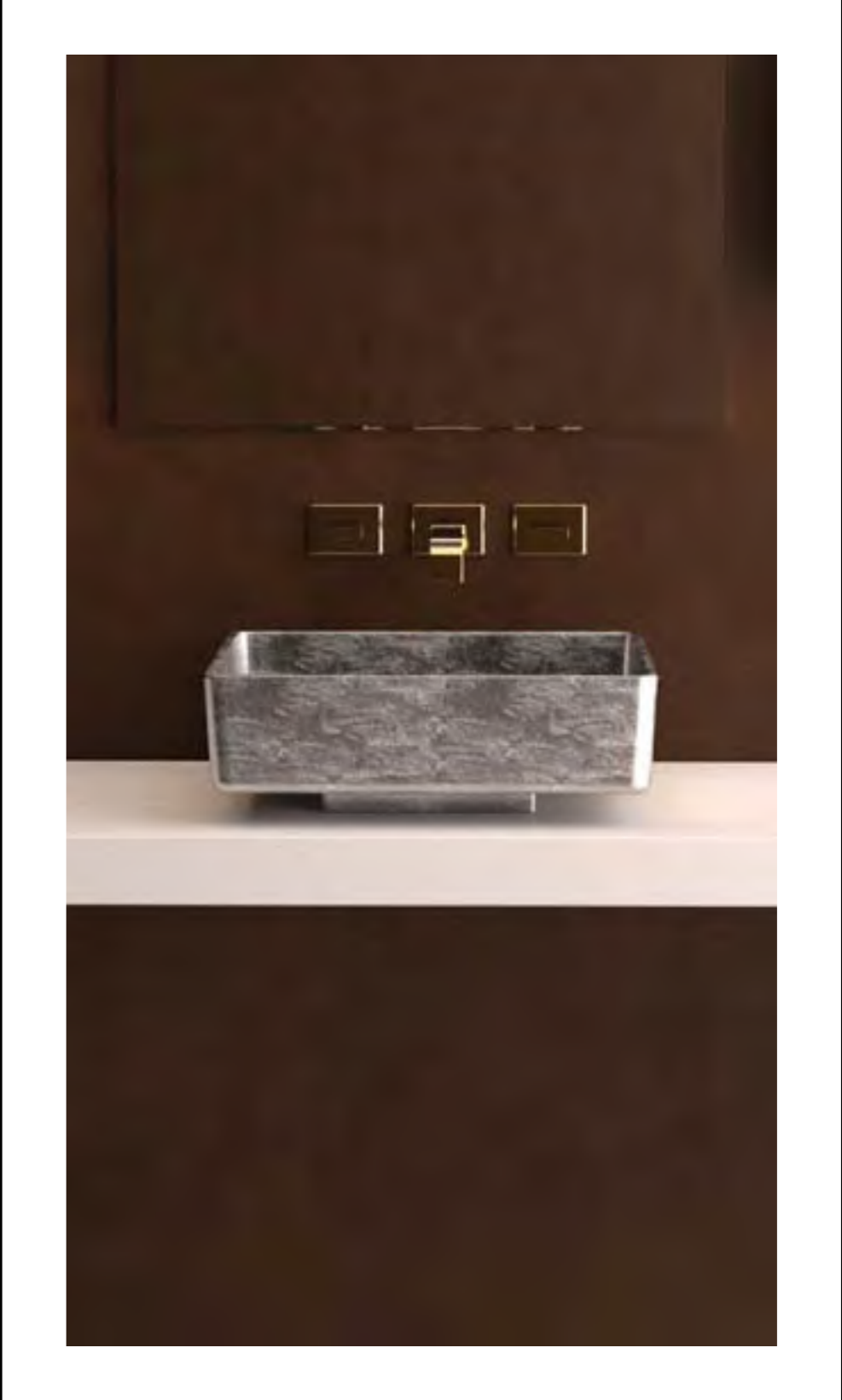

47

FOUR LUX code FOURFA



Four
Starlight

Pert®



FOUR STARLIGHT code FOURLH30



FOUR STARLIGHT code FOURLH05



FOUR STARLIGHT code FOURLH43



Four
Vision

Pert®



Blade Vision

Pert®



Infinity Colour

Pert®



design by

MD
MOGIDDESIGN

brevettato / patented

INFINITY COLOUR code **INFINITYPL34** Ferrari red



Infinity Starlight

Pert®



design by



INFINITY STARLIGHT code INFINITYLH30

brevettato / patented



INFINITY STARLIGHT code INFINITYLH01

brevettato / patented



Open

Pert®



OPEN code OPEN403



OPEN code OPEN807



OPEN code OPEN401 - OPEN406 - OPEN402



TeknoForm®

L'esaltazione delle superfici da molteplici materiali.
Enhancement of material surfaces.

TeknoForm® è il materiale delle "texture", costituito da polimeri di varia natura, si esprime dando vita a prodotti monoscocca, esaltando le sue superfici. Dai mosaici alle pietre, dai marmi ai legni, tante soluzioni che danno vita a prodotti unici.

TeknoForm® is a polymer-based material. It expresses itself by enhancing the surface of its products. From mosaics to stone, from marble to wood, an incredible variety of solutions can be realized in creating unique products.

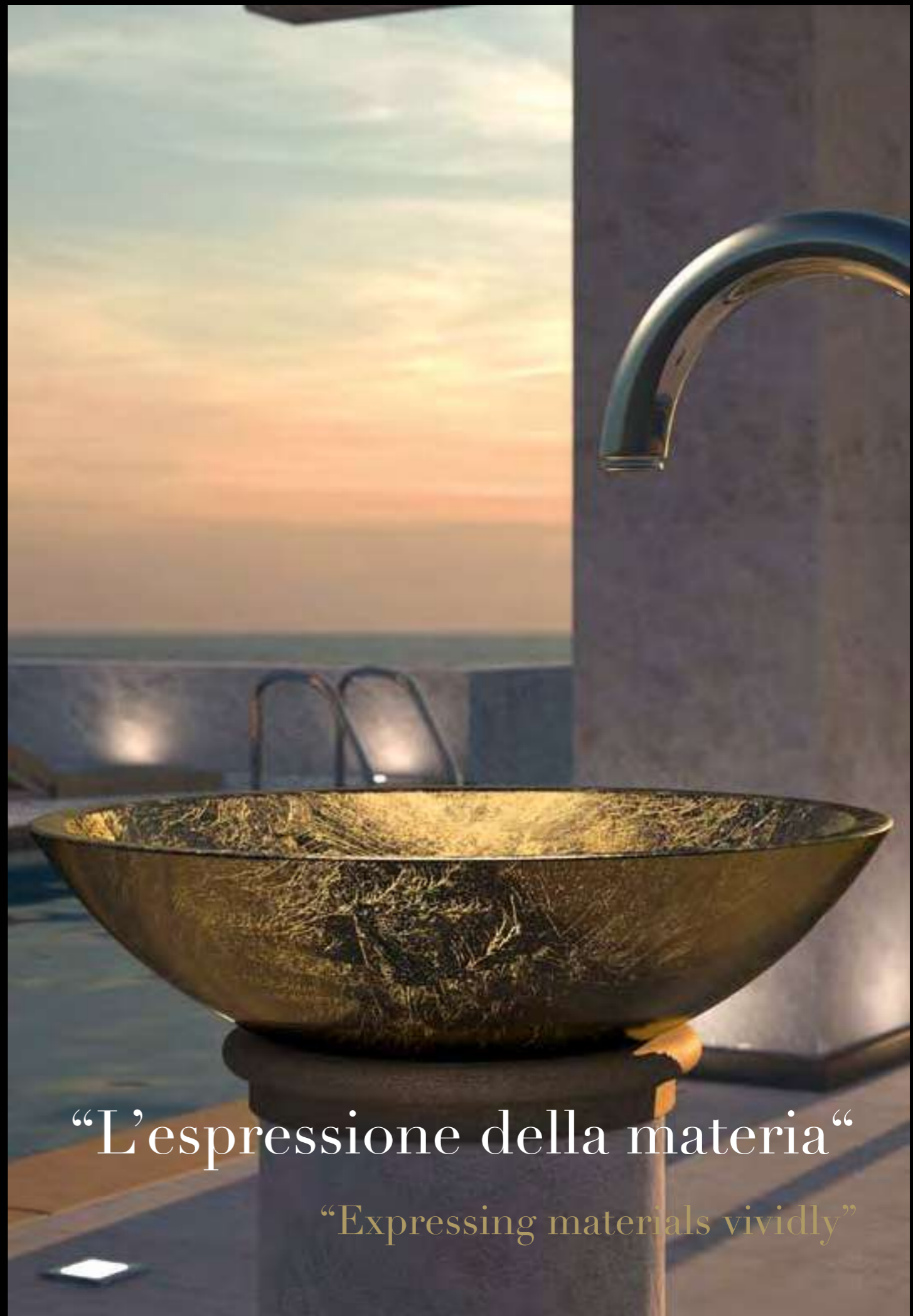

“L'espressione della materia”

“Expressing materials vividly”



Cocoon

TeknoForm®



COCOON code COCOONPLW



COCOON code COCOONGDW



Cocoon Lux

TeknoForm®



64

65

Mosaic

TeknoForm®



MOSAIC code MOSAICFA

Console MUSA - DA VINCI Collection

66



MOSAIC code MOSAICFA

Console MUSA - DA VINCI Collection



brevettato / patented

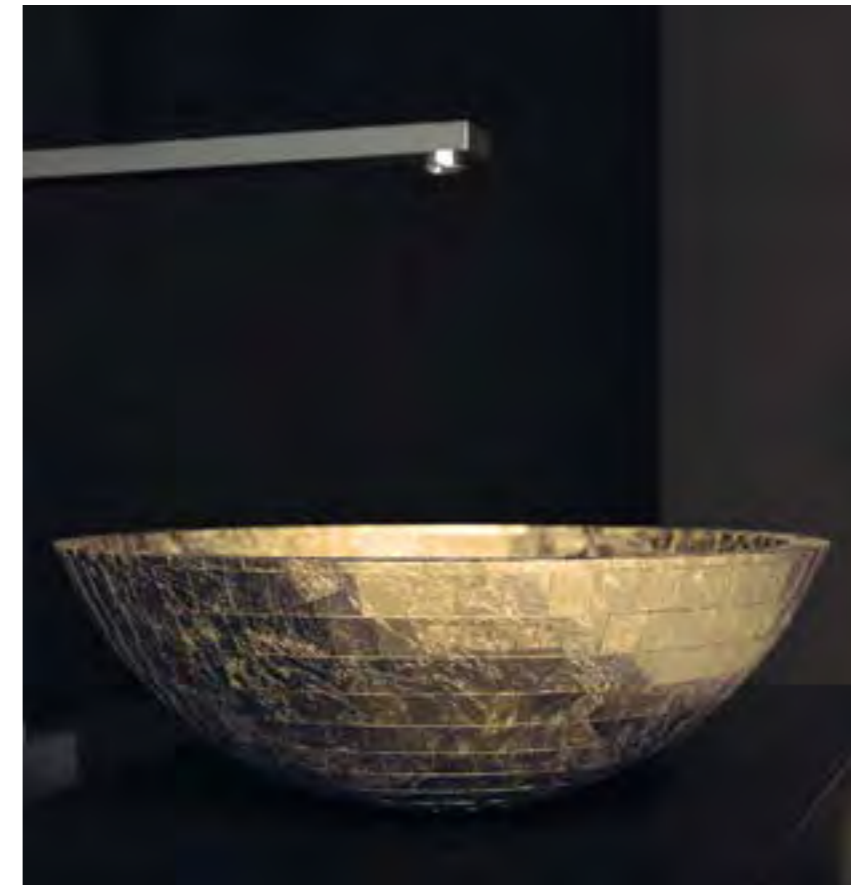

MOSAIC code MOSAICFO

67



brevettato / patented

Circus 50

TeknoForm®



CIRCUS50 code CIRCUS50FO



CIRCUS50 code CIRCUS50FA



Circus 43

TeknoForm®



CIRCUS43 code CIRCUS43FO



CIRCUS43 code CIRCUS43FA



CIRCUS43 code CIRCUS43PO30



CIRCUS43 code CIRCUS43PO01

Circus 43

Travertino

TeknoForm®



CIRCUS 43 TRAVERTINO code CIRCUS43ST31



Oval

Travertino

TeknoForm®



OVAL TRAVERTINO code OVALST01

73



OVAL TRAVERTINO code OVALST01



Rapolano

TeknoForm®



RAPOLANO 45 code RAP45B - RAP45N - RAP45ST - RAP45TC



RAPOLANO 45 code RAP45ST

Modo

Small - Max

TeknoForm®



MODO SMALL code MODOSMALLGDW

Yacht

TeknoForm®



YACHT code YACHTPO01



MODO MAX code MODOMAXDIW



Roma

design by: Cairoli - Donzelli

TeknoForm®



78

79

brevettato / patented

ROMA code ROMAFA



Alumix[®]
lega d'alluminio

L'hi-tech, elegante e contemporaneo.
Distinguishing with contemporary elegance.

Prodotto hi-tech, elegante e contemporaneo che nasce da una fusione di lega di alluminio. La decorazione è realizzata a pennello, con la tecnica del graffiato, per ottenere un effetto bicromatico. Il bordo è spazzolato e lucidato a mano, per valorizzare l'anima ed il colore tipico di questo materiale.

A high-tech product, both elegant and contemporary, born from a merger of aluminum alloys. The decorations are brush-painted, employing a special brush technique in order to obtain a bi-chromatic effect. The board is brushed and polished by hand to enhance the soul and color, which are typical for this material.



“L'espressione dell'Art-Tech”

“The expression of Art-Tech”



Exté
Lux

Alumix®



EXTE' LUX code ALUEXTELWG

brevettato / patented



EXTE' LUX code ALUEXTELWS



EXTE' LUX code ALUEXTELBG

brevettato / patented



Exté

Alumix®



EXTE' code ALUXTETA02

brevettato / patented



EXTE' code ALUXTETA05

brevettato / patented



Nek
Lux

Alumix[®]



NEK LUX code ALUNEKLBS



NEK LUX code ALUNEKLBG



NEK LUX code ALUNEKLWG



Nek

Alumix®



NEK code ALUNEKTA02



NEK code ALUNEKTA05



NEK code ALUNEKTA03



Ares

Alumix®



ARES code **ALUARESA02**
Console MUSA - DA VINCI Collection
Bath accessories GLAMOUR code **GLAMSETA05**



ARES code **ALUARESA07**



ARES code **ALUARESA08**



Round

Alumix®



ROUND code **ALUROA05**
Bath accessories GLAMOUR code **GLAMSETA05**

brevettato / patented



ROUND code **ALUROA04**
Bath accessories GLAMOUR code **GLAMSETA04**



ROUND code **ALUROA02**
Bath accessories GLAMOUR code **GLAMSETA02**



brevettato / patented

Vogue

Alumix®



VOGUE code ALUVOA02
Bath accessories GLAMOUR code GLAMSETA02

brevettato / patented



VOGUE code ALUVOA03
Bath accessories GLAMOUR code GLAMSETA03

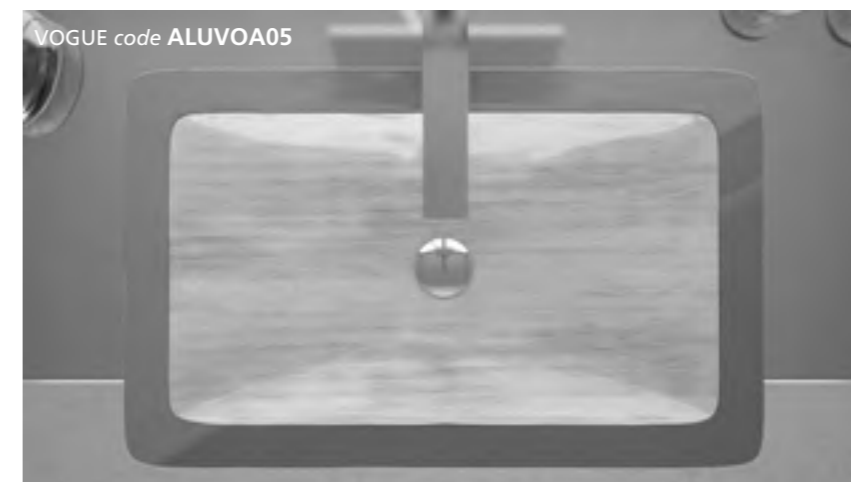

VOGUE code ALUVOA05



brevettato / patented

made with
MURANO[®]
glass

Dalla tradizione millenaria un oggetto unico e prestigioso.
Creating masterpieces with artisan traditions.

Il vetro di Murano è da sempre sinonimo di raffinatezza, leggerezza ed eleganza.

I maestri vetrai hanno saputo sviluppare tecniche di lavorazioni privilegiate, nel rispetto della millenaria tradizione che rende il vetro di Murano un prodotto unico, prestigioso e inimitabile.

Murano glass is a synonym for elegance and timelessness.

By combining innovative techniques with traditional artisan workmanship, unique, prestigious and inimitable objects are created.



“Il privilegio dell’inimitabile”

“The privilege of individualism”

Calla Black

made with
MURANO[®]
glass

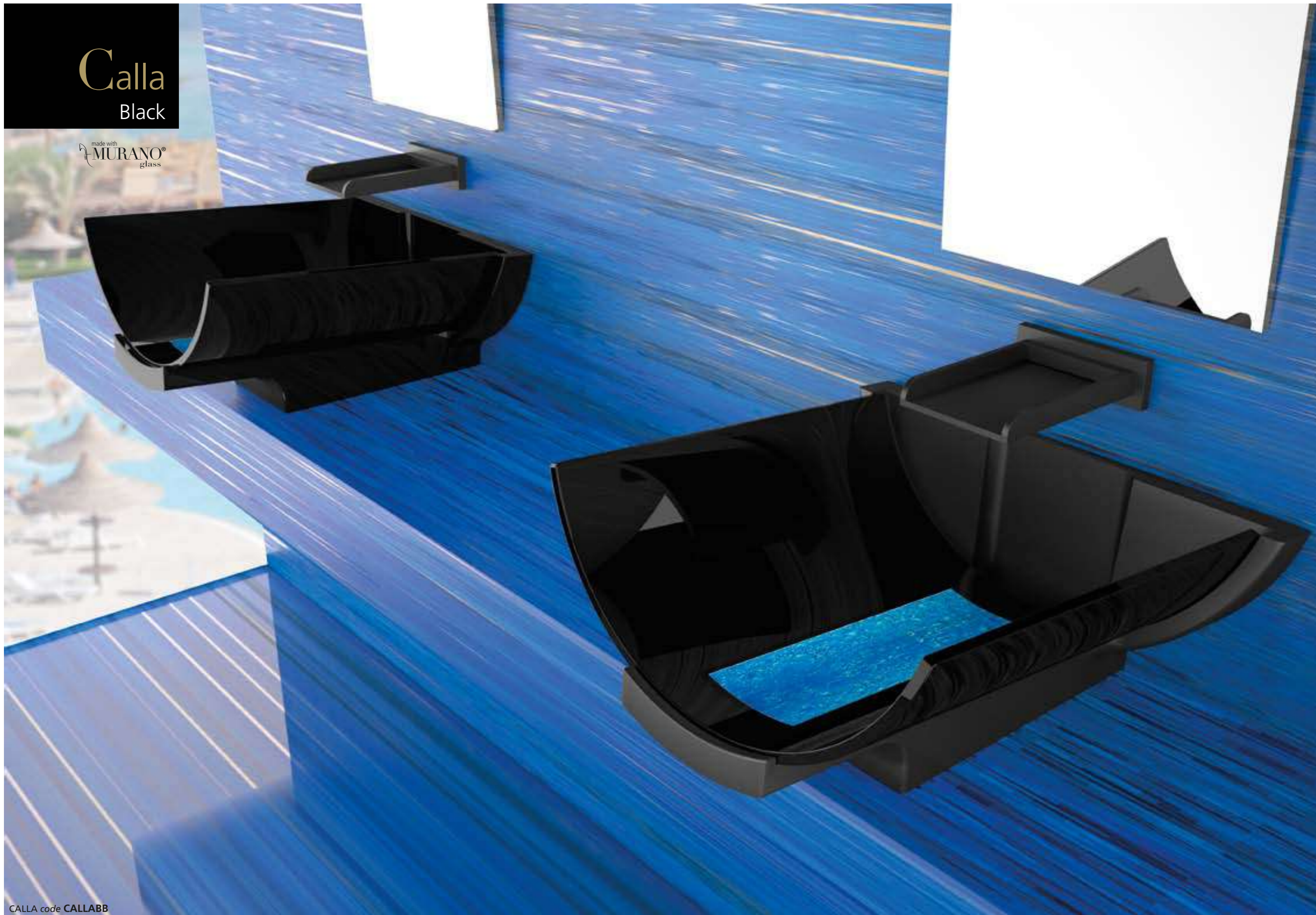

98

99

CALLA code CALLABB



Calla Black

made with
MURANO[®]
glass



CALLA code CALLABS

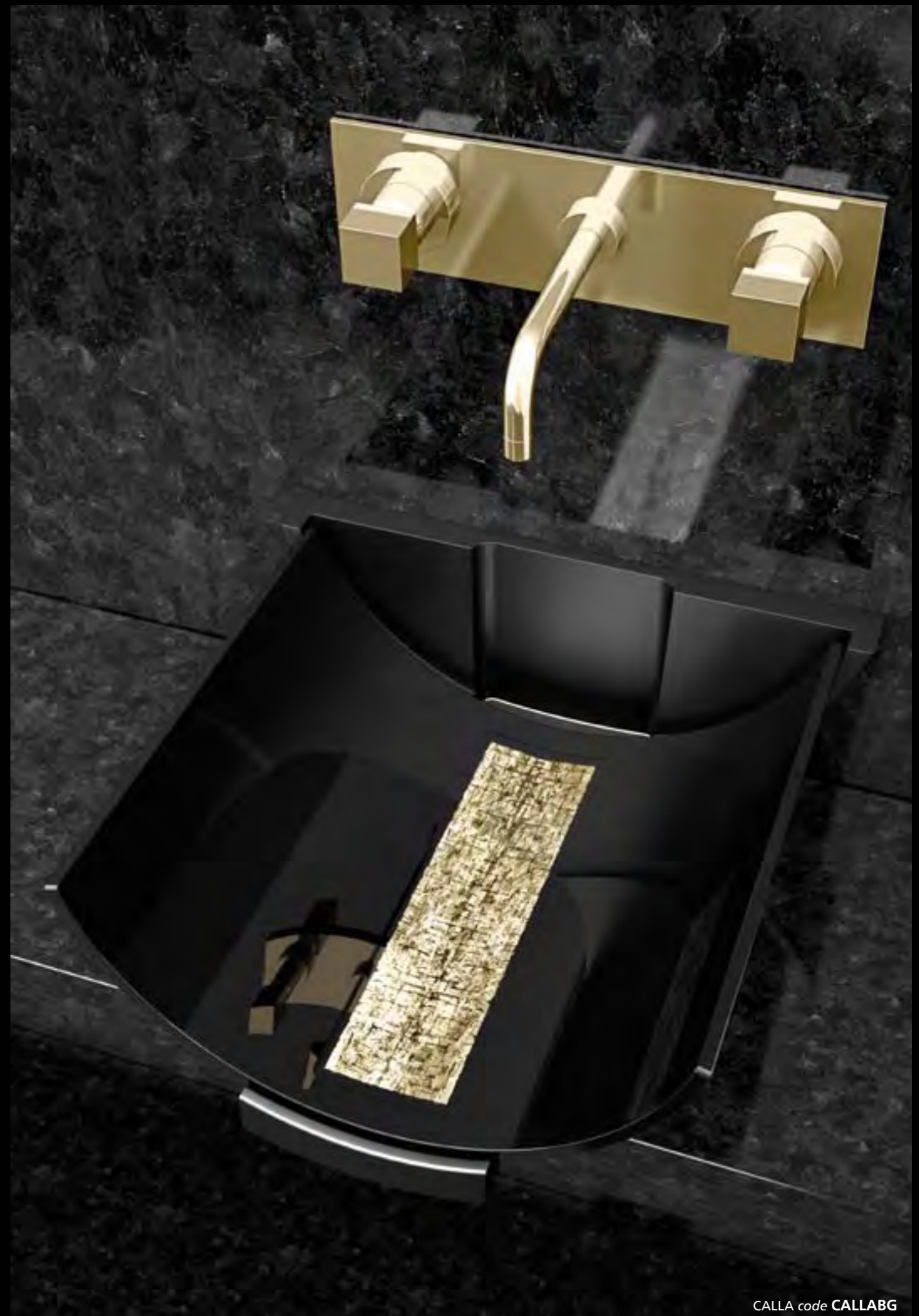

CALLA code CALLABG



Calla

made with
MURANO[®]
glass



design by

MD
MOGIDDESIGN

CALLA code CALLACR01

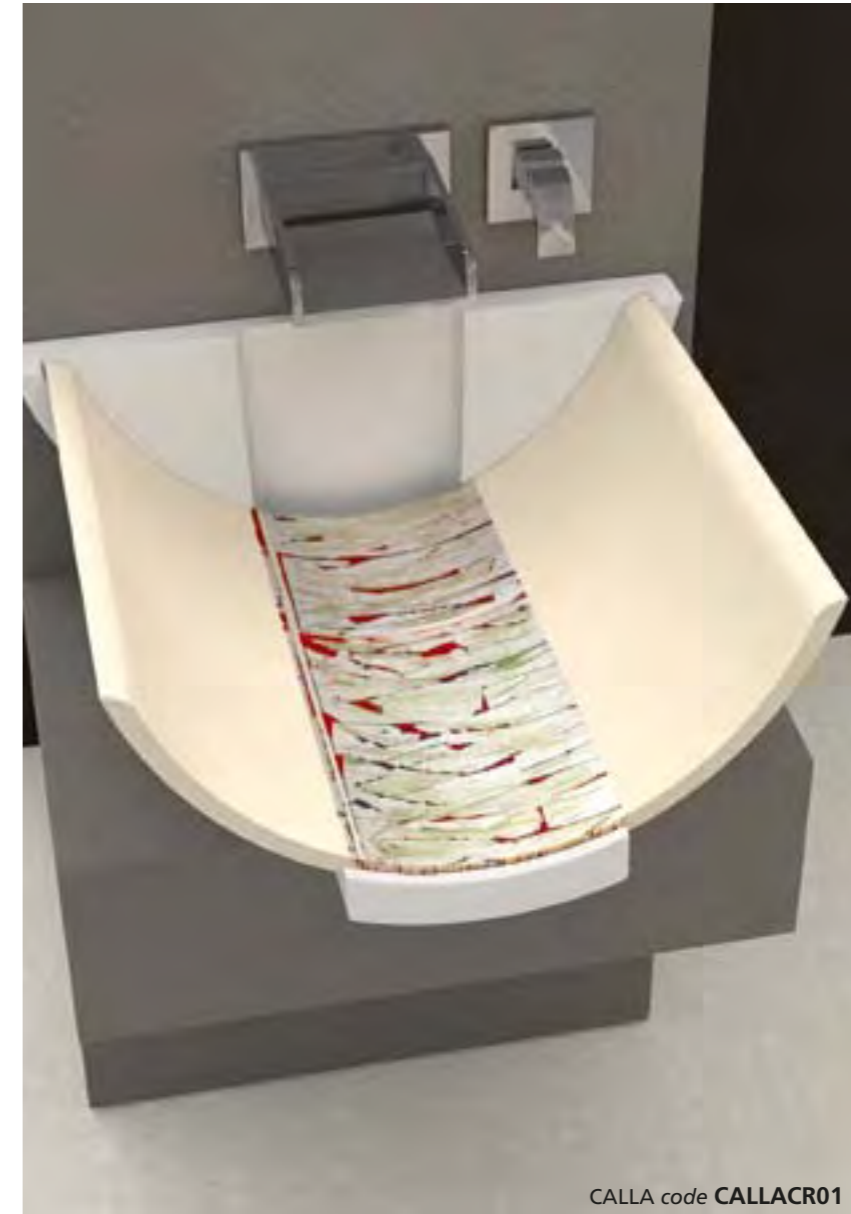

CALLA code CALLACR01



Laguna Vintage

made with
MURANO[®]
glass



LAGUNA VINTAGE code LAGUNAVN



Laguna Rossa

made with
MURANO[®]
glass



LAGUNA ROSSA code LAGUNARO



Laguna Night

made with
MURANO[®]
glass



LAGUNA NIGHT code LAGUNAT33



Laguna Oro

made with
MURANO[®]
glass



LAGUNA ORO code LAGUNAGD



Laguna Red

made with
MURANO[®]
glass

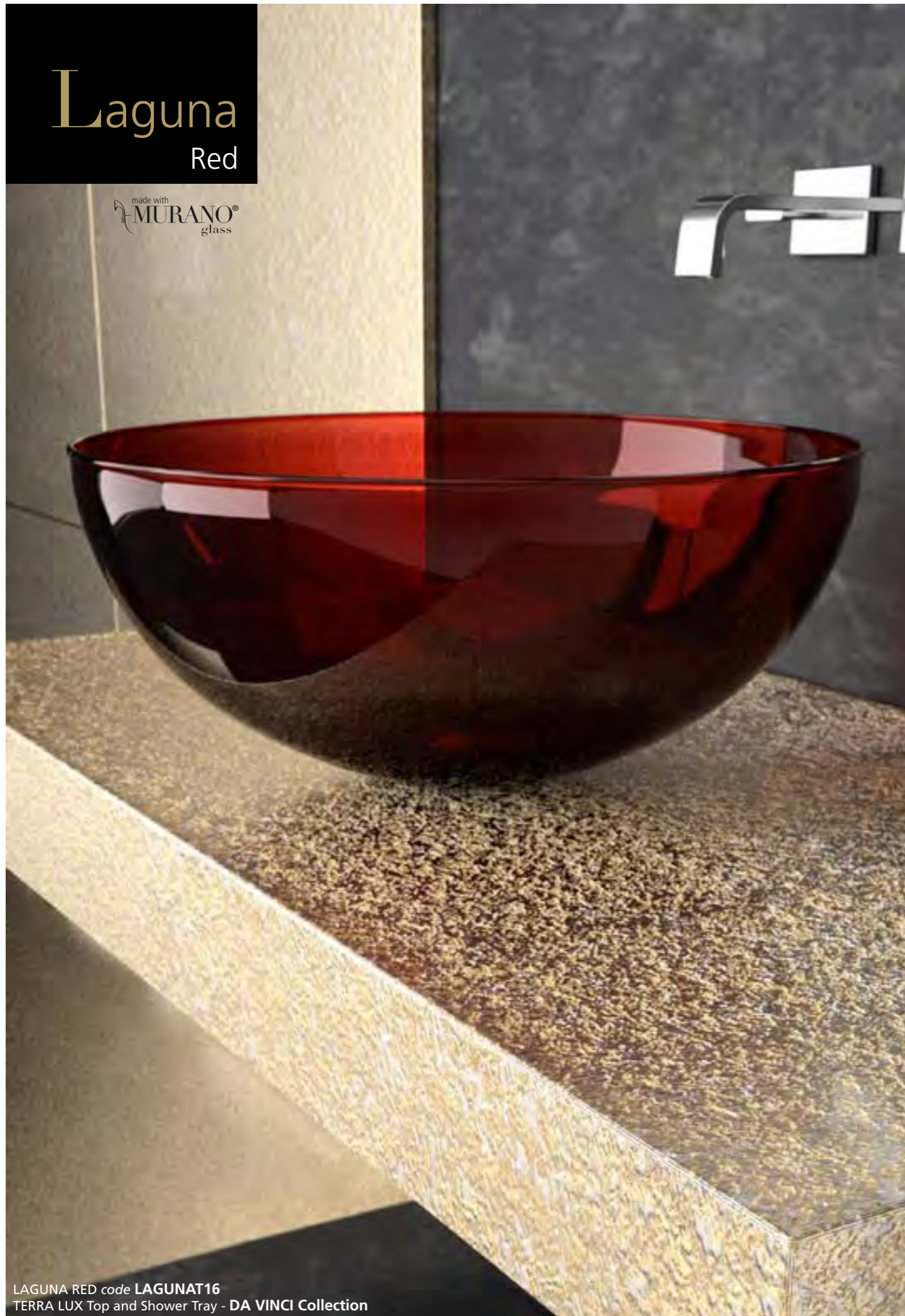

LAGUNA RED code LAGUNAT16
TERRA LUX Top and Shower Tray - DA VINCI Collection



Laguna Smoke

made with
MURANO[®]
glass



LAGUNA SMOKE code LAGUNAT43
TERRA Top and Shower Tray - DA VINCI Collection



Laguna

Blue

made with
MURANO[®]
glass



LAGUNA BLUE code LAGUNAT42
TERRA Top and Shower Tray - DA VINCI Collection



Canale

made with
MURANO[®]
glass

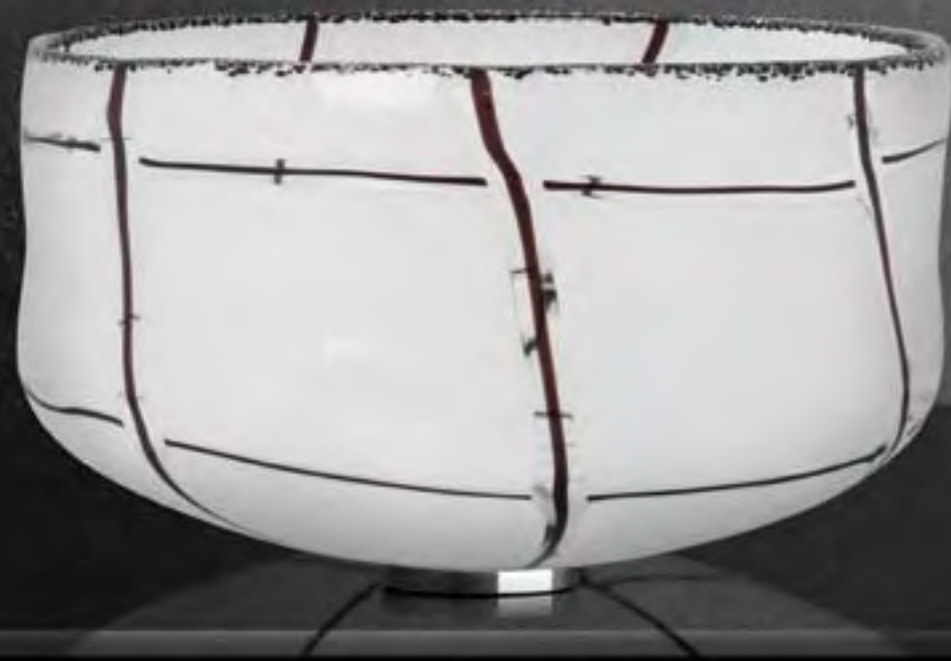

CANALE code **CANALEWB**



Ottico

made with
MURANO[®]
glass



OTTICO code **OTTICOGW**



Gondola

made with
MURANO[®]
glass



114

GONDOLA code GONDOLATX01

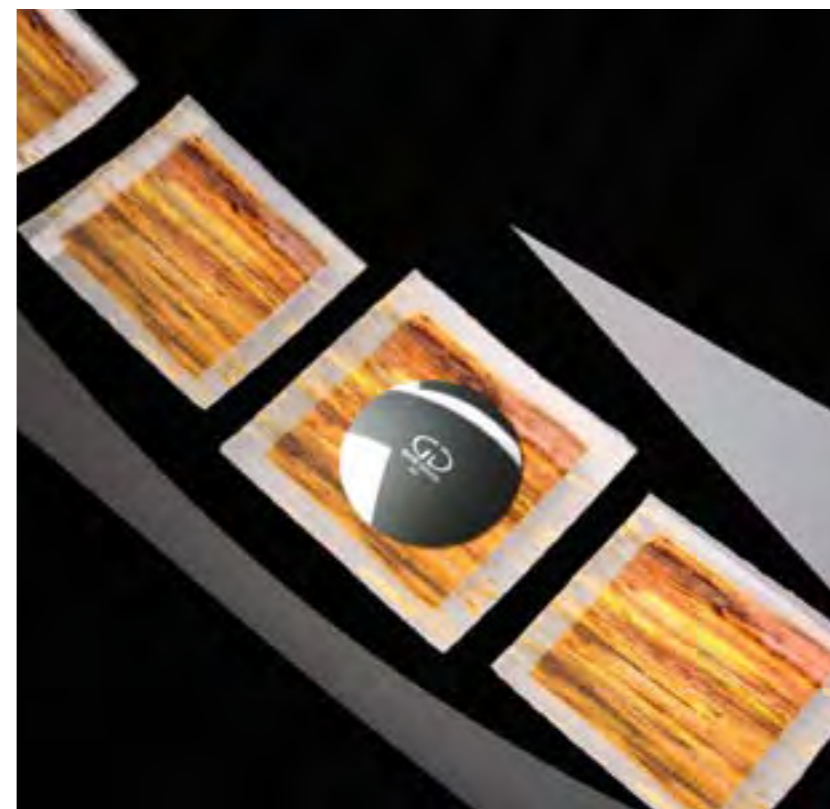

115

GONDOLA code GONDOLATX01



Carnival

made with
MURANO[®]
glass



CARNIVAL code CARNIVALCR01

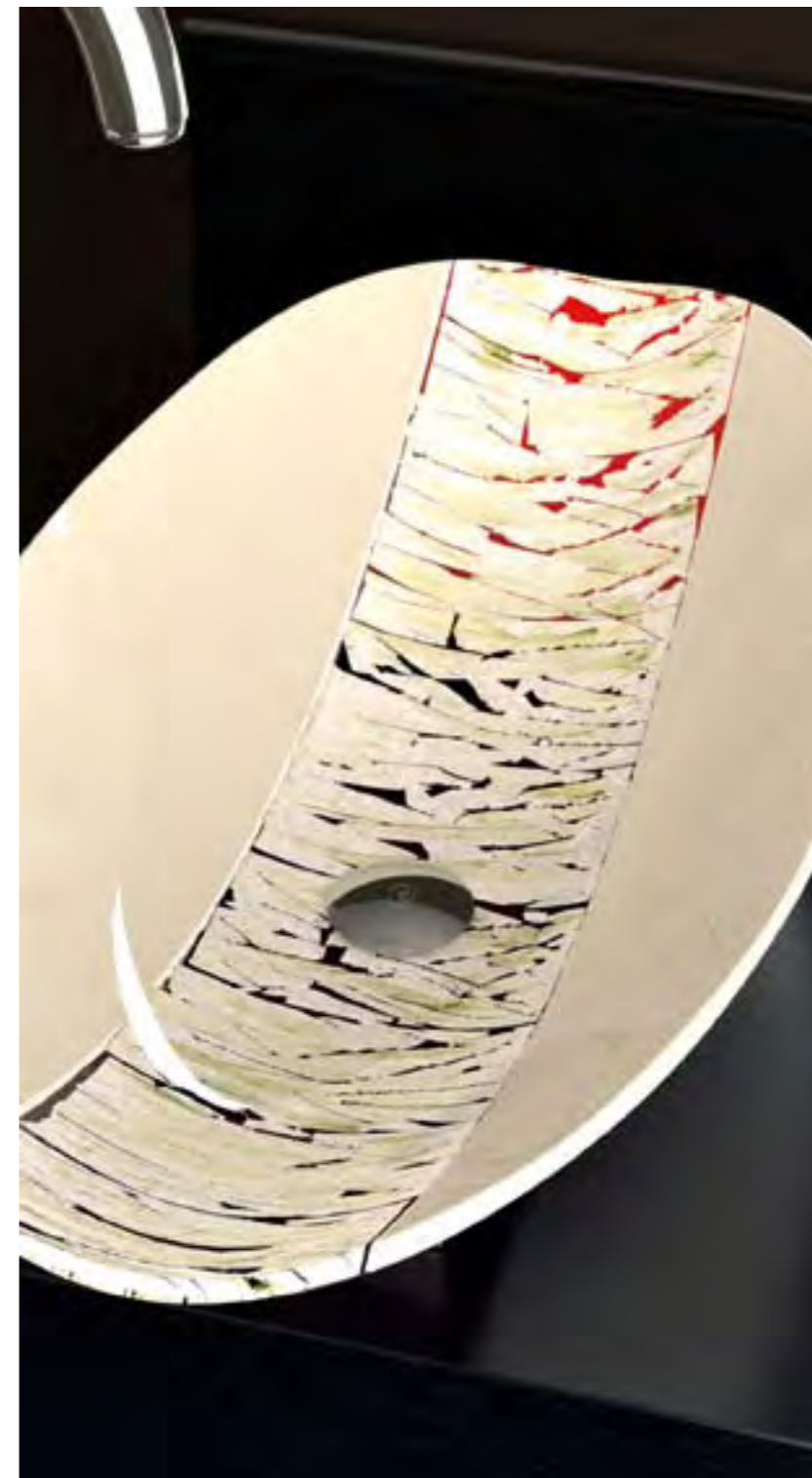

CARNIVAL code CARNIVALCR01



Gondola Spring

made with
MURANO[®]
glass

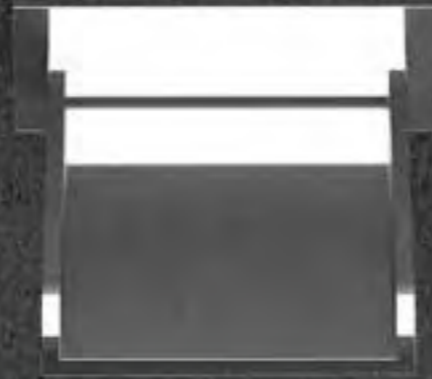

GONDOLA SPRING code GONDOLASPR01



Glo Ball Murano

made with
MURANO[®]
glass



GLO BALL MURANO code GLOBALMT33 - GLOBALMT43 - GLOBALMT05



brevettato / patented



GLO BALL MURANO code GLOBALMT36



brevettato / patented

 Cristallo[®]
DE' MEDICI
Pb 24%

Dalle più antiche e nobili arti vetrarie.
From the ancient and noble glass arts.

Collezioni esclusive, realizzate in cristallo purissimo al 24% pb.
Si tratta di prodotti raffinatissimi, soffiati a bocca e molati a pietra con
abilità, dai nostri maestri secondo le più antiche e nobili arti vetrarie.
Nessuna macchina, nessuna tecnologia, ma solo prodotti d'arte,
classici, contemporanei ... futuristici.

Exclusive collections created from pure crystal with 24% lead content.
These utmost refined products are mouth-blown and bevelled in stone
by our master artists according to the most ancient and noble glass
arts. Neither machines nor technology are employed in the process,
resulting in classical, contemporary or futuristic art products.



“Il Cristallo: collezioni d'arte”

“The Crystal: art collections”



Collier

Cristallo
DE MEDICI
Pb 24%



COLLIER code COLLIERT30
Clear crystal knob - ARIUS HOME collection



Ice Oval

Cristallo
DE MEDICI
Pb 24%

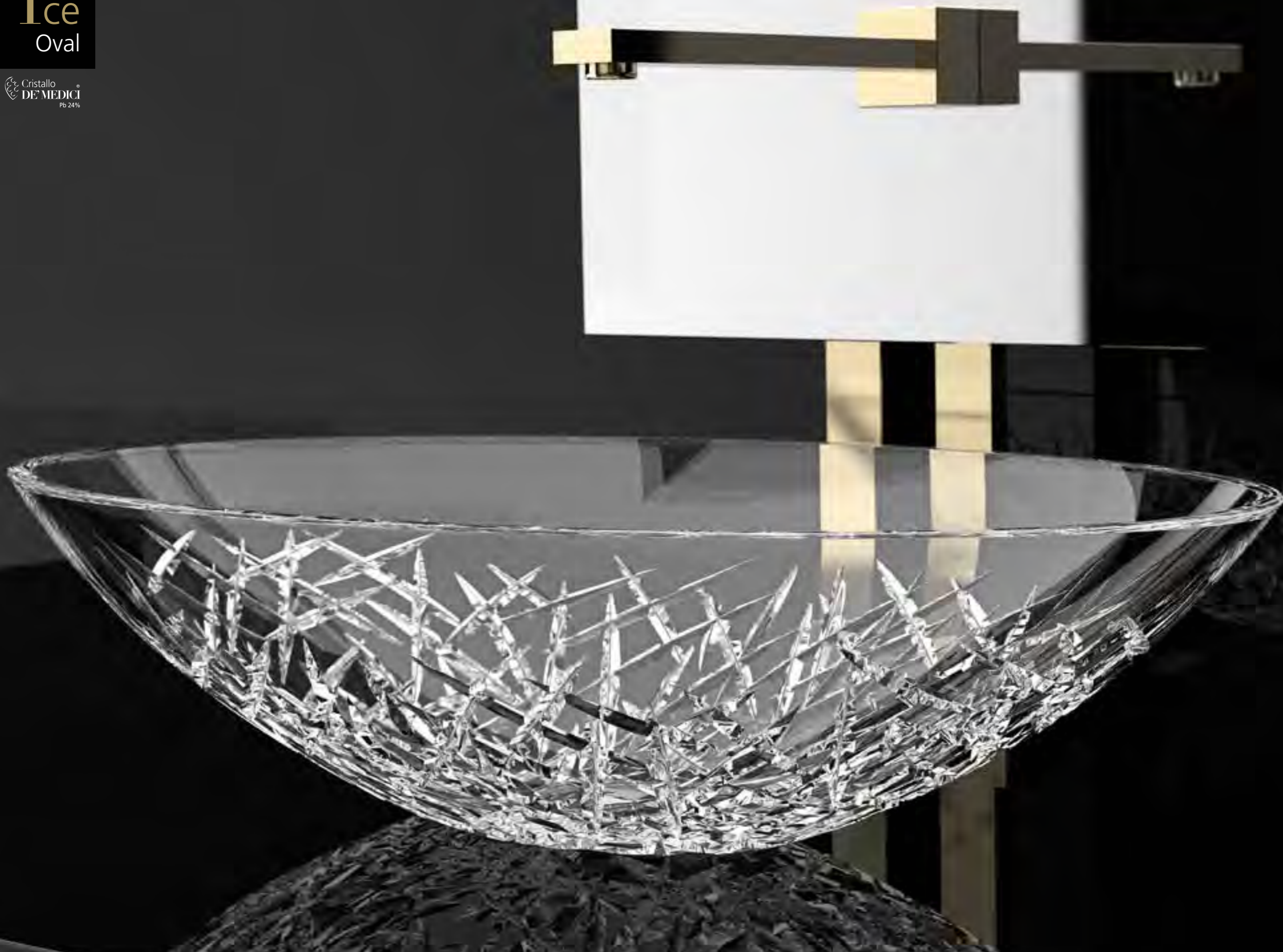

ICE OVAL code ICEOVT01



brevettato / patented

126

127

Ice Oval Lux

Cristallo
DE MEDICI
Pb 24%



ICE OVAL LUX code ICEOVGDF3



brevettato / patented



brevettato / patented

Luxor

Oval

Cristallo
DE MEDICI
Pb 24%

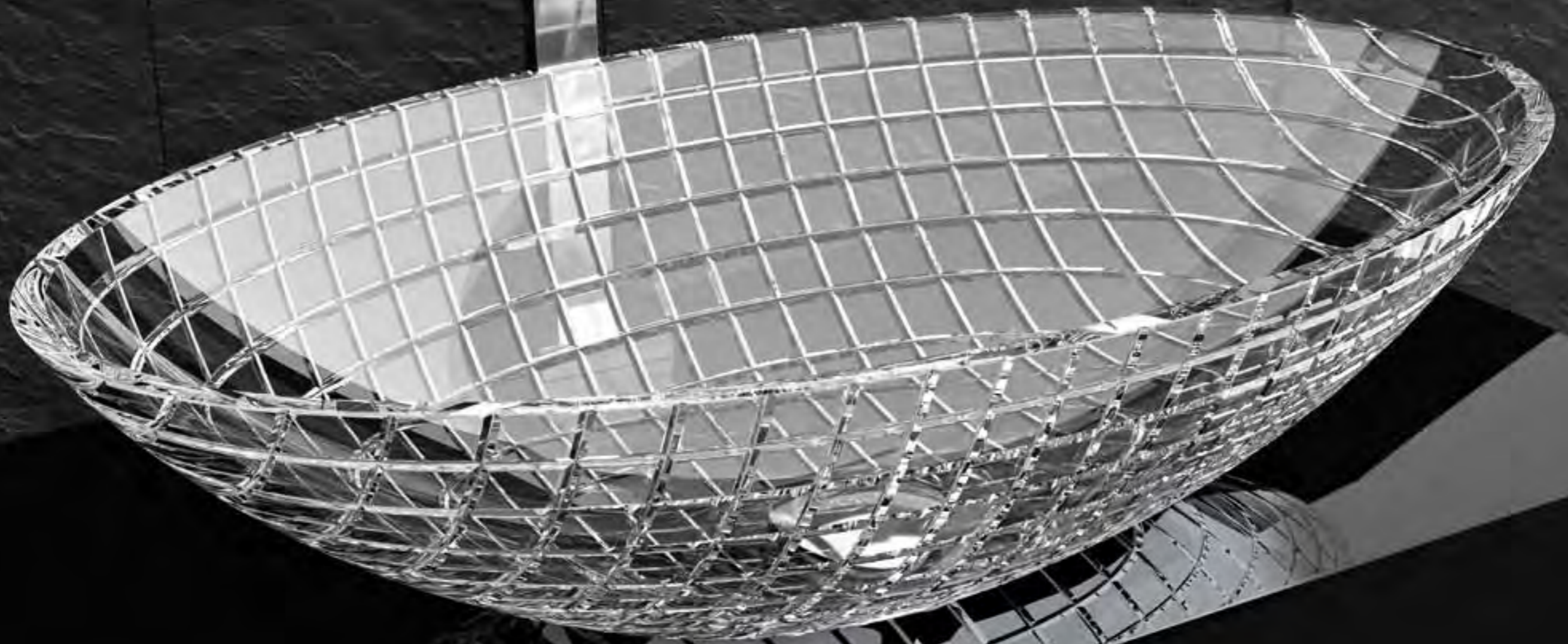

LUXOR OVAL code LUXOROV01



brevettato / patented

Moon

Cristallo
DE MEDICI
Pb 24%



MOON code MOONT01



brevettato / patented

Chelo

Cristallo
DE MEDICI
Pb 24%



CHELO code CHELOT30



Chelo

Cristallo
DE MEDICI
Pb 24%



CHELO code CHELOT01



Clivia

Cristallo
DE MEDICI
Pb 24%



CLIVIA code CLIVIAT01



Clivia

Cristallo
DE MEDICI
Pb 24%



CLIVIA code CLIVIAT35
Black crystal faucet handles - GLAMOROUS TUNING collection



Marinus

Cristallo
DE MEDICI
Pb 24%

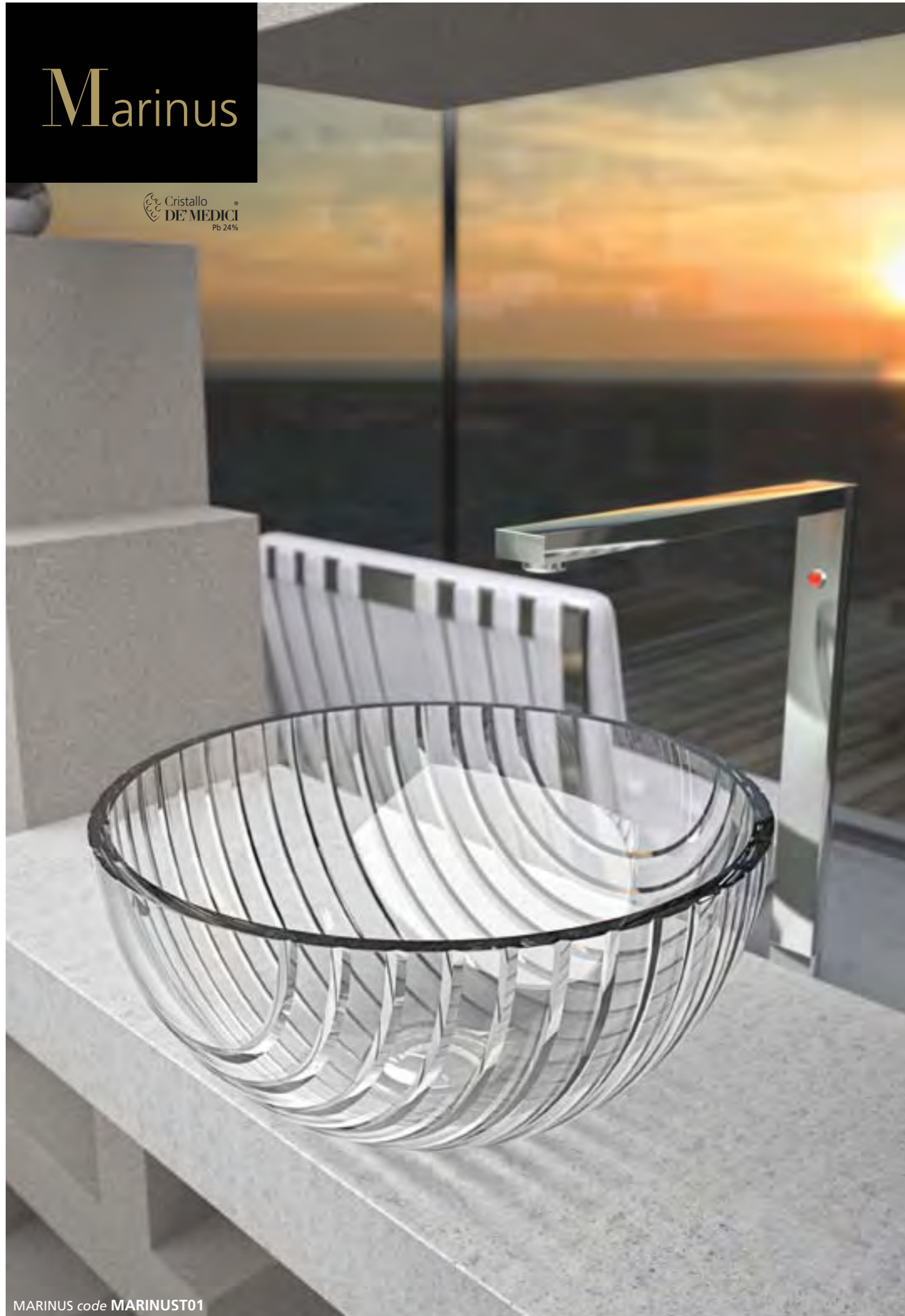

MARINUS code MARINUST01



Ramada

Cristallo
DE MEDICI
Pb 24%



RAMADA code RAMADAT01
Clear crystal faucet handles - GLAMOROUS TUNING collection

CANTO XL furniture - DA VINCI Collection
Clear crystal knobs - ARIUS HOME collection



138

139

Aqua

Cristallo
DE MEDICI
Pb 24%



AQUA code **AQUAT01**
Bath accessories NAVY code **NVSETPO30**



AQUA code **AQUAT30**



Moon

Over Ice

Cristallo
DE MEDICI
Pb 24%

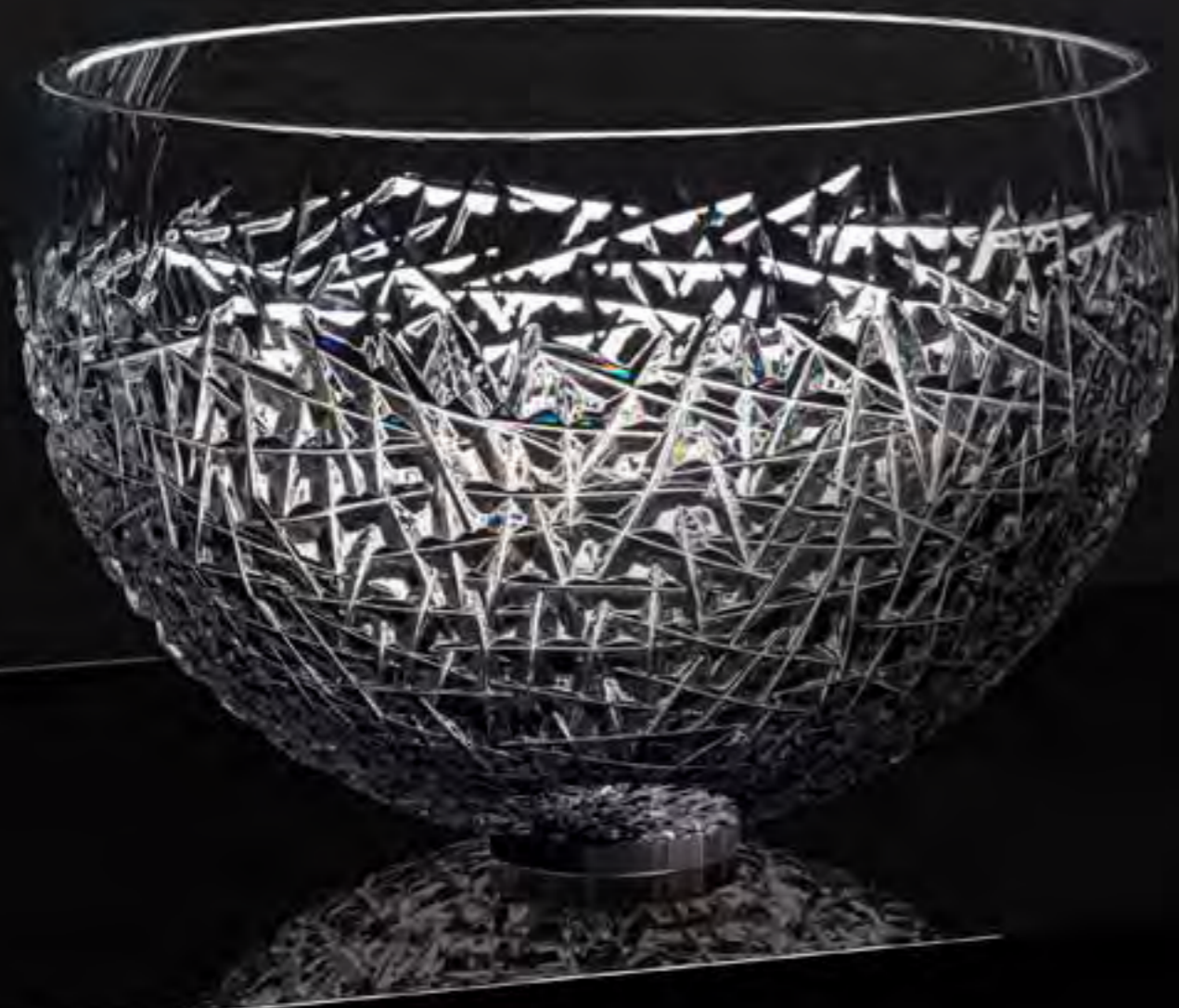

You can't see other

MOON OVER ICE code **MOONOVICET01**
Clear crystal faucet handles - **GLAMOROUS TUNING** collection



brevettato / patented

142

143

Glo Ball

Crystal Ice

Cristallo
DE MEDICI
Pb 24%



144

GLOBAL CRYSTAL ICE code **GLOBALICET01**
Clear crystal faucet handles - **GLAMOROUS TUNING** collection



145

brevettato / patented

Glo Ball

Crystal Ramada

Cristallo
DE MEDICI
Pb 24%



146

GLOBAL CRYSTAL RAMADA code **GLOBALLRAMT01**
Clear crystal faucet handles - **GLAMOROUS TUNING** collection



147

Florence Glass
ATELIER[®]

L'ultima tendenza di oggetti decorati a mano.
Avant-garde trends in artisan product design.

Il progetto Atelier nasce dalla ricerca stilistica che una nostra equipe interna realizza rivolgendo lo sguardo al mondo della moda. I colori e le texture che vengono rappresentati nel programma sono la sintesi delle nuove tendenze.

The "Florence Glass Atelier" project is inspired by embedding the philosophy of the fashion world into product research. The focus lays on enhancing crystal material with colours and textures of fashion trends.

“Collezioni esclusive
dal mondo della moda”
“Exclusive collection
inspired by the fashion world”

Venice

Florence Glass
ATELIER®



VENICE code VENICE44OA



VENICE code VENICE40AN



VENICE code VENICE44MA



Graffiti

Florence Glass
ATELIER®

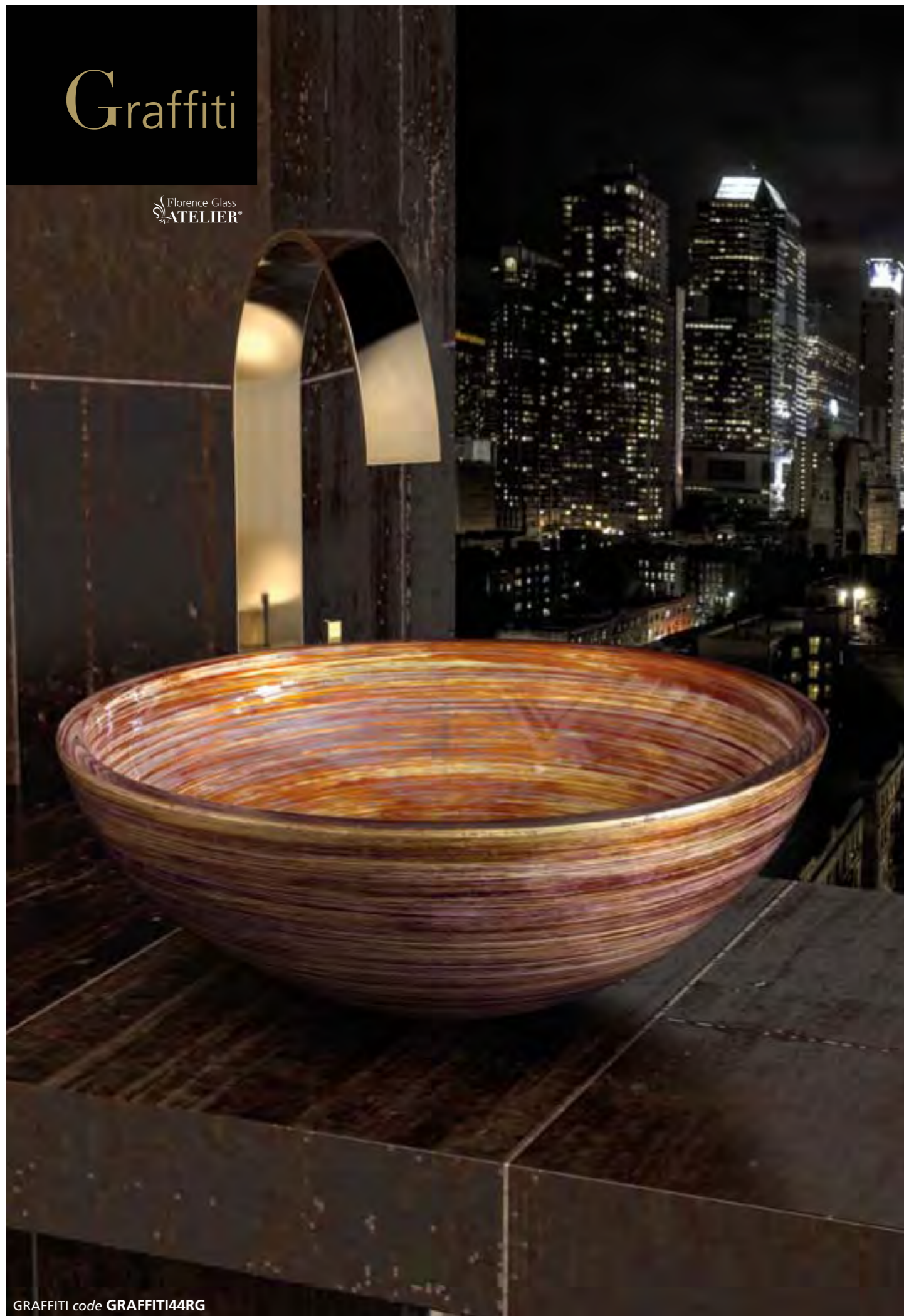

GRAFFITI code **GRAFFITI44RG**



GRAFFITI code **GRAFFITI40BG**



Luna

Florence Glass
ATELIER®



“Tecnologia esclusiva”
“Exclusive technology”

LUNA code LUNA44YL



brevettato / patented

La pietra come fonte di ispirazione. Il risultato è una speciale combinazione del cemento applicato sul cristallo.

Natural stone, a source of inspiration, reflected in a uniquely decorative application of concrete to crystal.



LUNA code LUNA45GR



brevettato / patented

154

155

Luna Katino

Florence Glass
ATELIER®



LUNA KATINO code KATINOLGR



brevettato / patented

Luna Forma

Florence Glass
ATELIER®



LUNA FORMA code FORMALSN



brevettato / patented

Filigrana

Florence Glass
ATELIER®



FILIGRANA 40 code **FILIGRANA40RG**

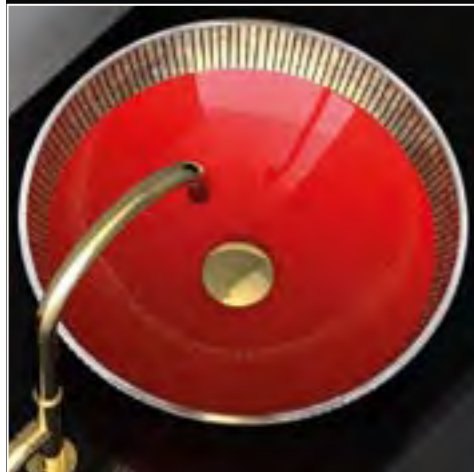

FILIGRANA 40 code **FILIGRANA40BS**
overflow joint code TP



brevettato / patented

Flare Tech

Florence Glass
ATELIER®

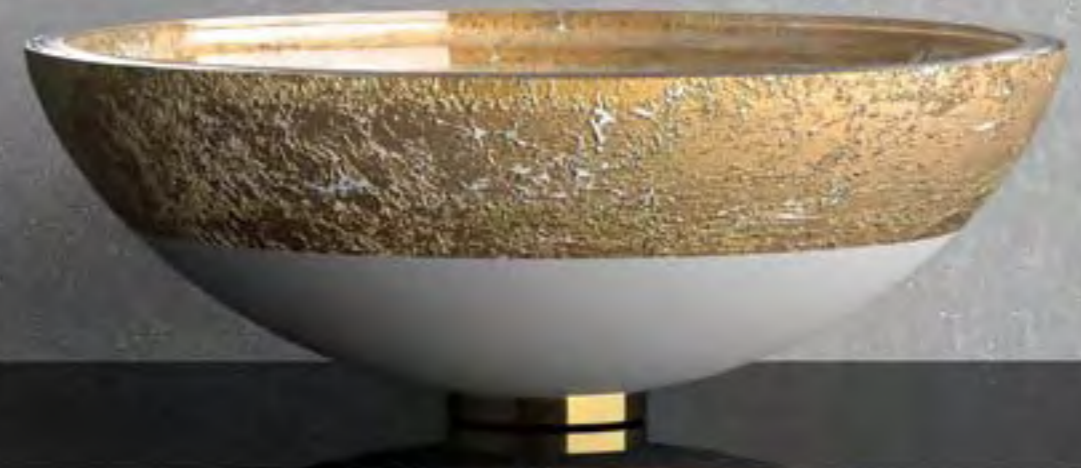

FLARE TECH 40 code **FLARET40WG**

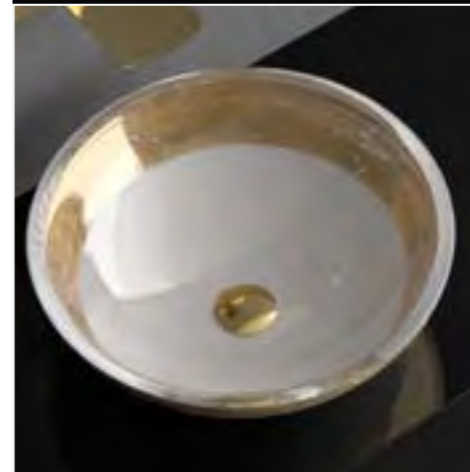

FLARE TECH 40 code **FLARET40BS**
overflow joint code TP



brevettato / patented

158

159

Flare

Florence Glass
ATELIER



FLARE 40 code FLARE40S01

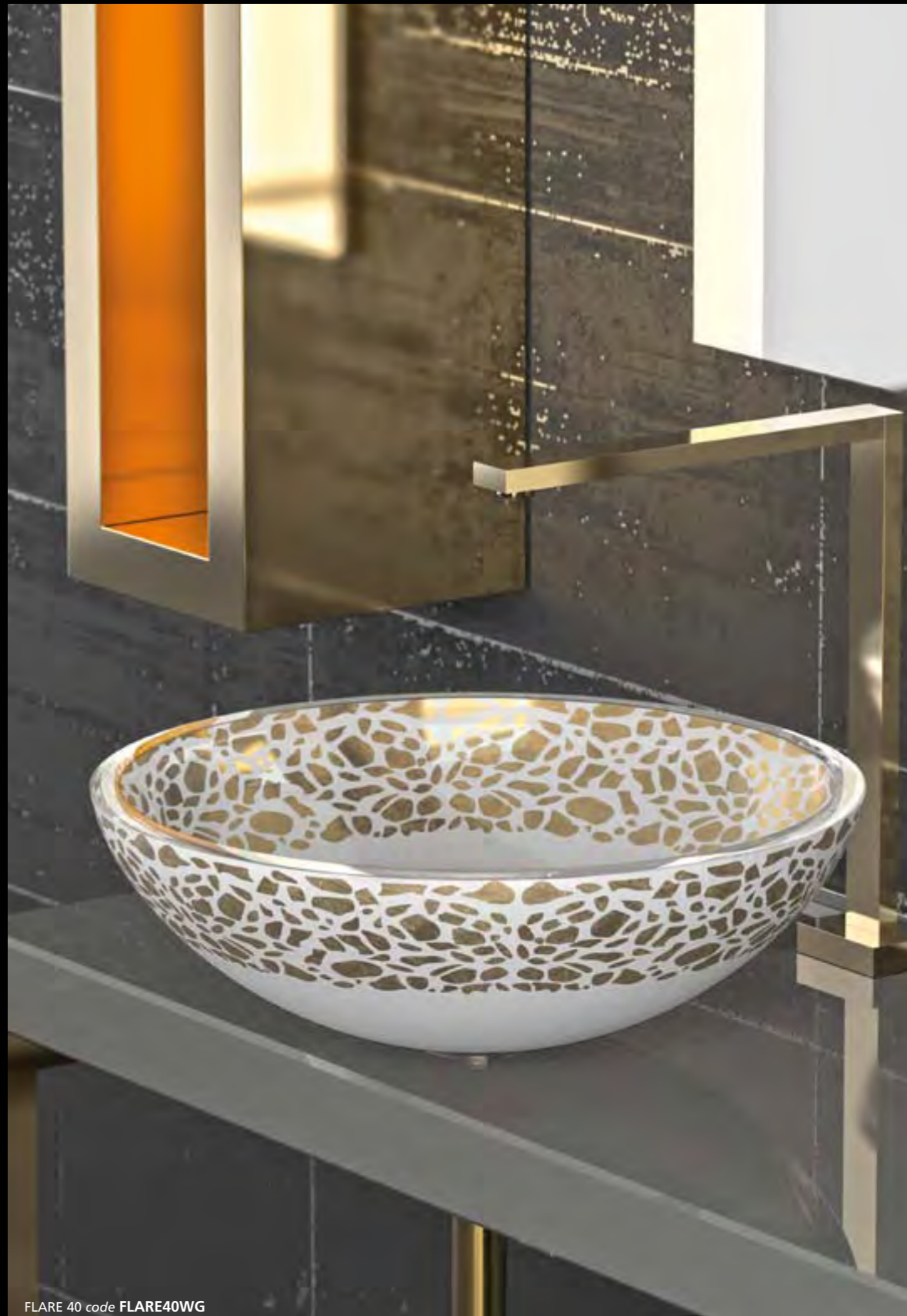

FLARE 40 code FLARE40WG



160

161

Kalahari

Florence Glass
ATELIER



KALAHARI 40 code KALAHARI40WG

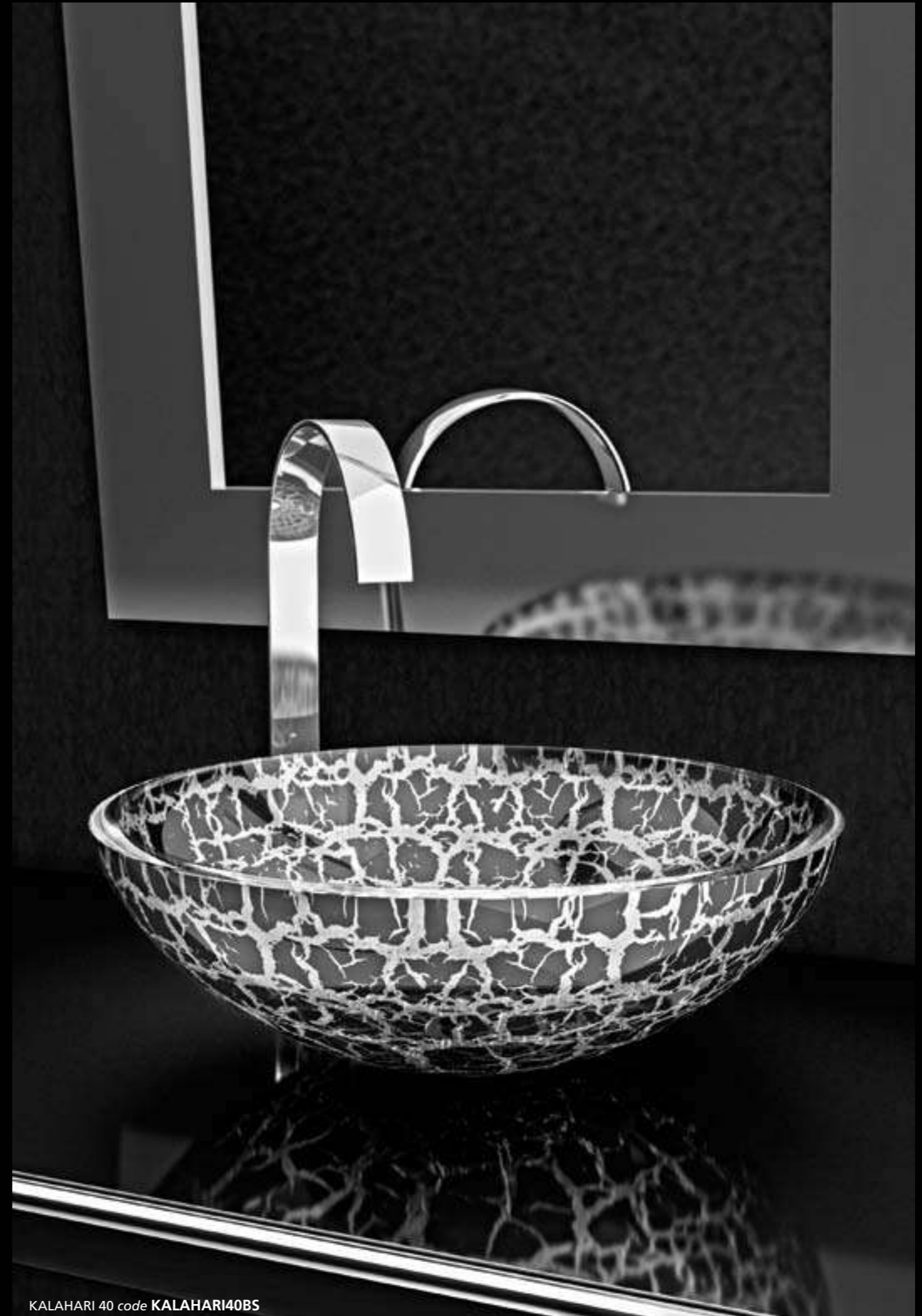

KALAHARI 40 code KALAHARI40BS



Xeni

Florence Glass
ATELIER

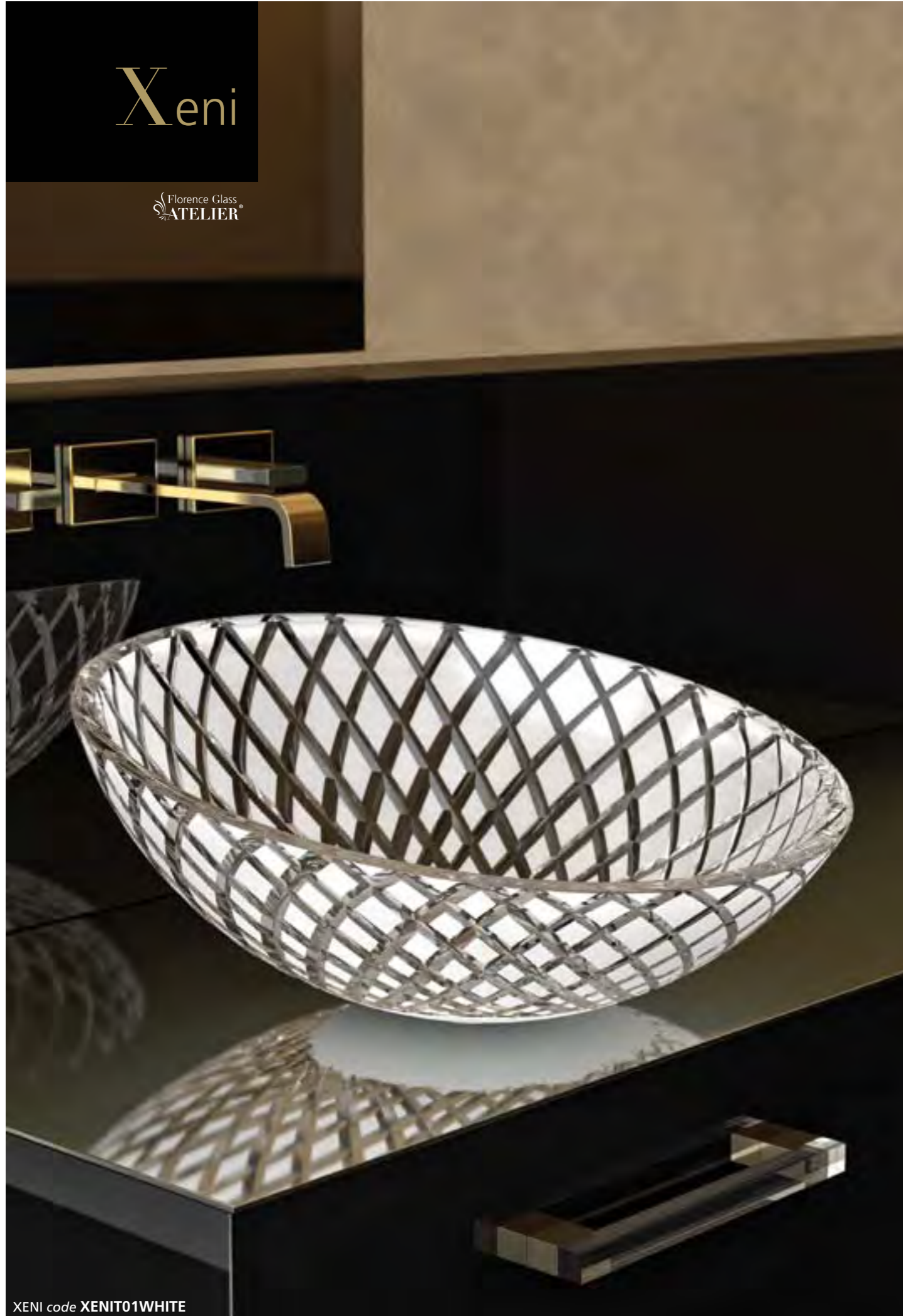

XENI code XENIT01WHITE



brevettato / patented



XENI code XENIT30BLACK



brevettato / patented

164

165

Flo

Florence Glass
ATELIER



Artistic glass hand-made.
Some tiny bubbles may appear in the basin, highlighting the character of objects individually made by hand by our master glassmakers.

FLOU code **FLOUT01**
CANTO XL furniture - **DA VINCI Collection**
Clear crystal knobs - **ARIUS HOME Collection**



Soffio

Florence Glass
ATELIER



Artistic glass hand-made.
Some tiny bubbles may appear in the basin, highlighting the character of objects individually made by hand by our master glassmakers.



SOFFIO code **SOFFIOT01**
overflow joint code **TP**

SOFFIO code **SOFFIOT01**



Tekno Materic

Florence Glass
ATELIER®



TEKNO MATERIC code **TEKNO40BO**



brevettato / patented

Tekno Metal

Florence Glass
ATELIER®



TEKNO METAL code TEKNO40BZ



brevettato / patented

Tekno Lux

Florence Glass
ATELIER®



TEKNO LUX code TEKNO40LGD



brevettato / patented

174

175

Filò
Katino

Florence Glass
ATELIER®



FILO' KATINO code FILOK39AM



brevettato / patented

Bamboo Katino

Florence Glass
ATELIER®



BAMBOO KATINO code **BAMBOOK39GR**
Clear crystal faucet handles - **GLAMOROUS TUNING** collection



Oasy

Florence Glass
ATELIER®

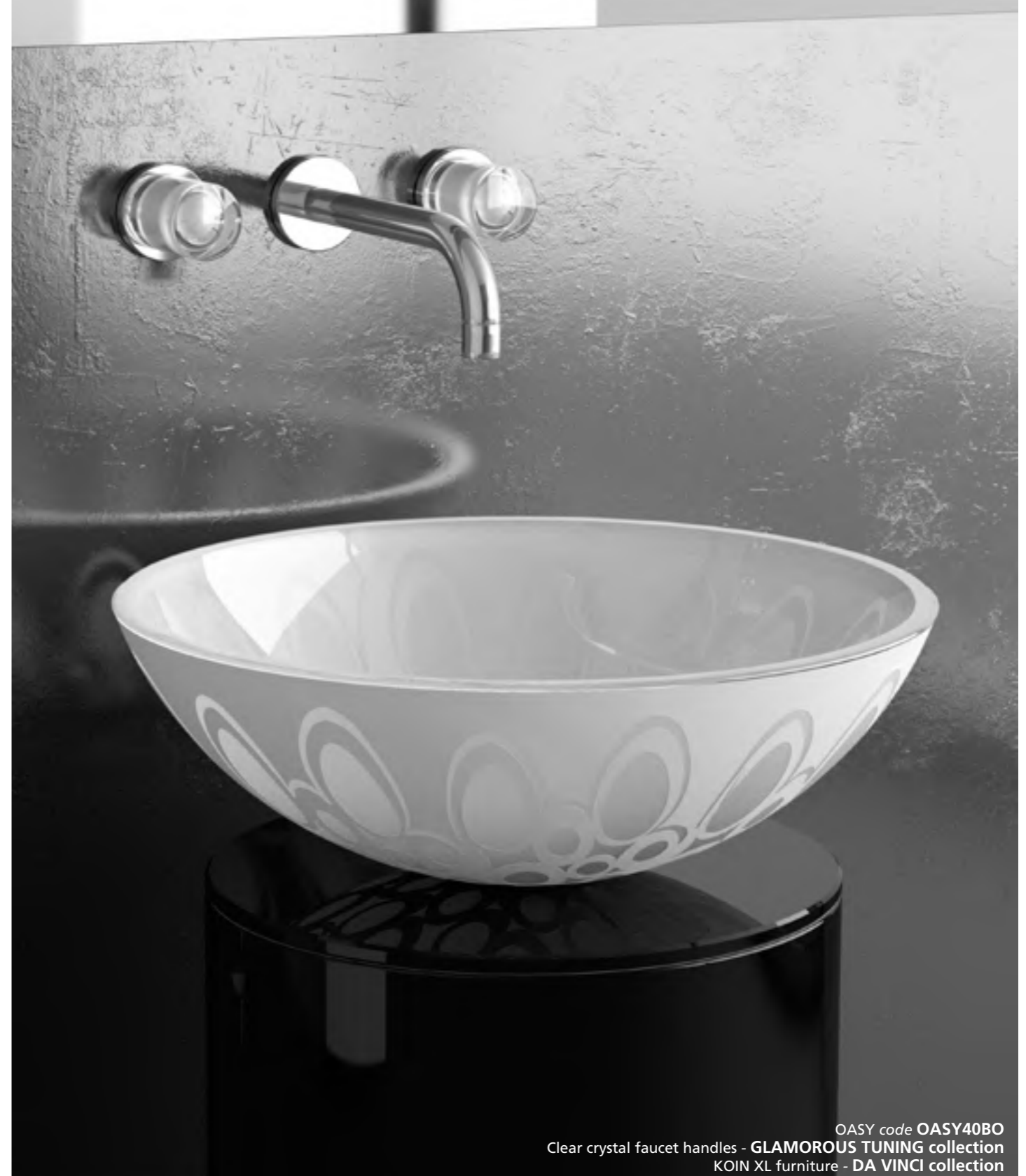

OASY code **OASY40BO**
Clear crystal faucet handles - **GLAMOROUS TUNING** collection
KOIN XL furniture - **DA VINCI** collection



Perla

Florence Glass
ATELIER

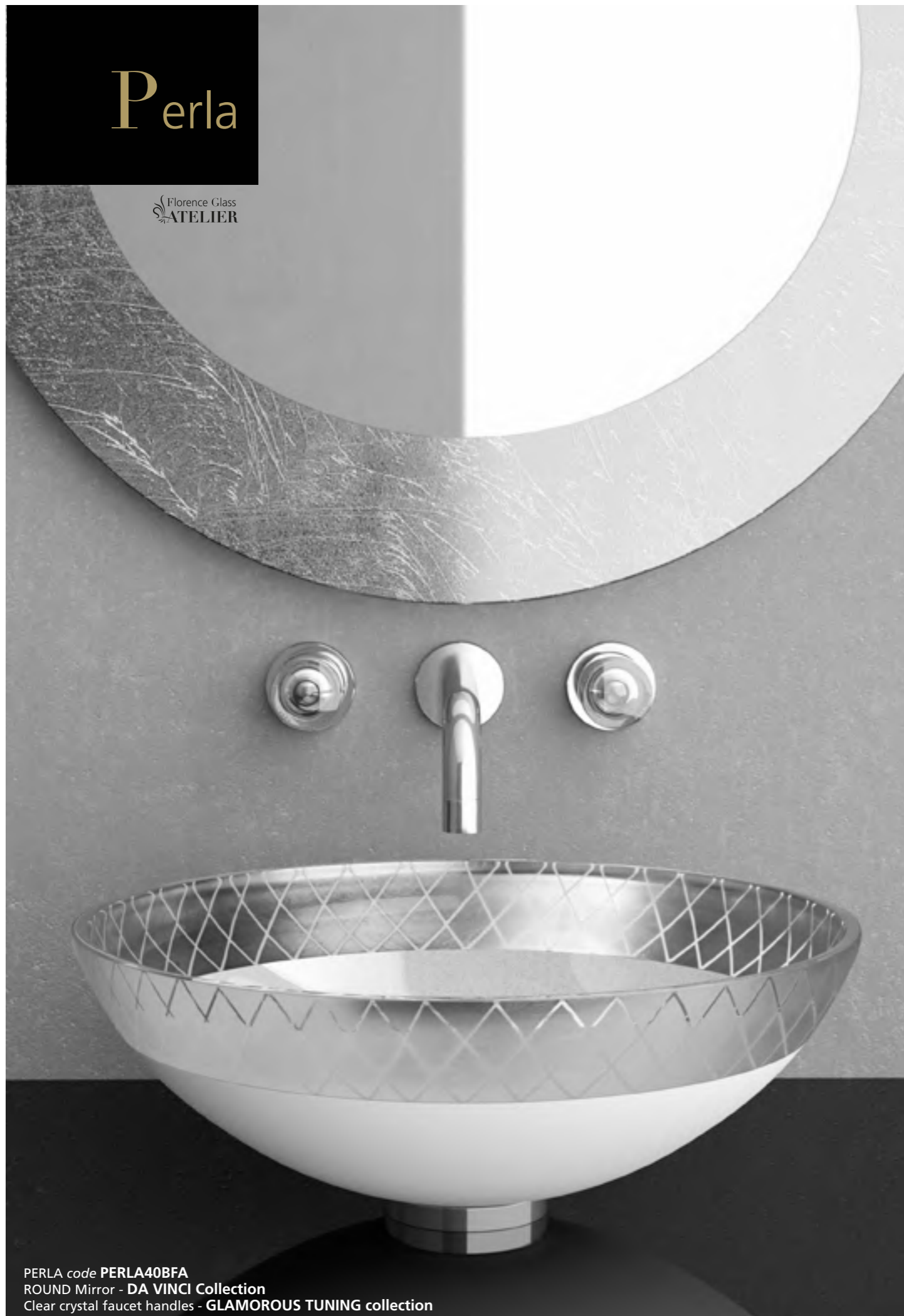

PERLA code **PERLA40BFA**
ROUND Mirror - **DA VINCI** Collection
Clear crystal faucet handles - **GLAMOROUS TUNING** collection



brevettato / patented

Onda

Florence Glass
ATELIER



ONDA code **ONDA40BFO**
ROUND Mirror - **DA VINCI** Collection



brevettato / patented

180

181

Globo

Florence Glass
ATELIER®



GLOBO code GLOBO34BO - GLOBO34NO



brevettato / patented

Loop

Florence Glass
ATELIER®



LOOP code LOOP40RD
Clear crystal faucet handles - GLAMOROUS TUNING Collection
CANTO XL furniture - DA VINCI Collection
Black crystal knobs - ARIUS HOME Collection



INOX ZERO®

L'evoluzione dell'inox.
Inox evolution.

Nuova tecnologia applicata per dar vita ad un prodotto inox (18/8) tridimensionale.

Peso specifico ridottissimo nonostante i volumi.

Varie sono le espressioni cromatiche dal colore tipico dell'inox lucido, spazzolato fino all'ultima generazione di colori high-tech.

The products of the INOX ZERO Collection are made out of stainless steel (18/8), utilising advanced production processes enabling the combination of expressive design with of low weight. A wide range of colours can be achieved, from timeless metallic shades to prestigious brushed and avant-garde colours.

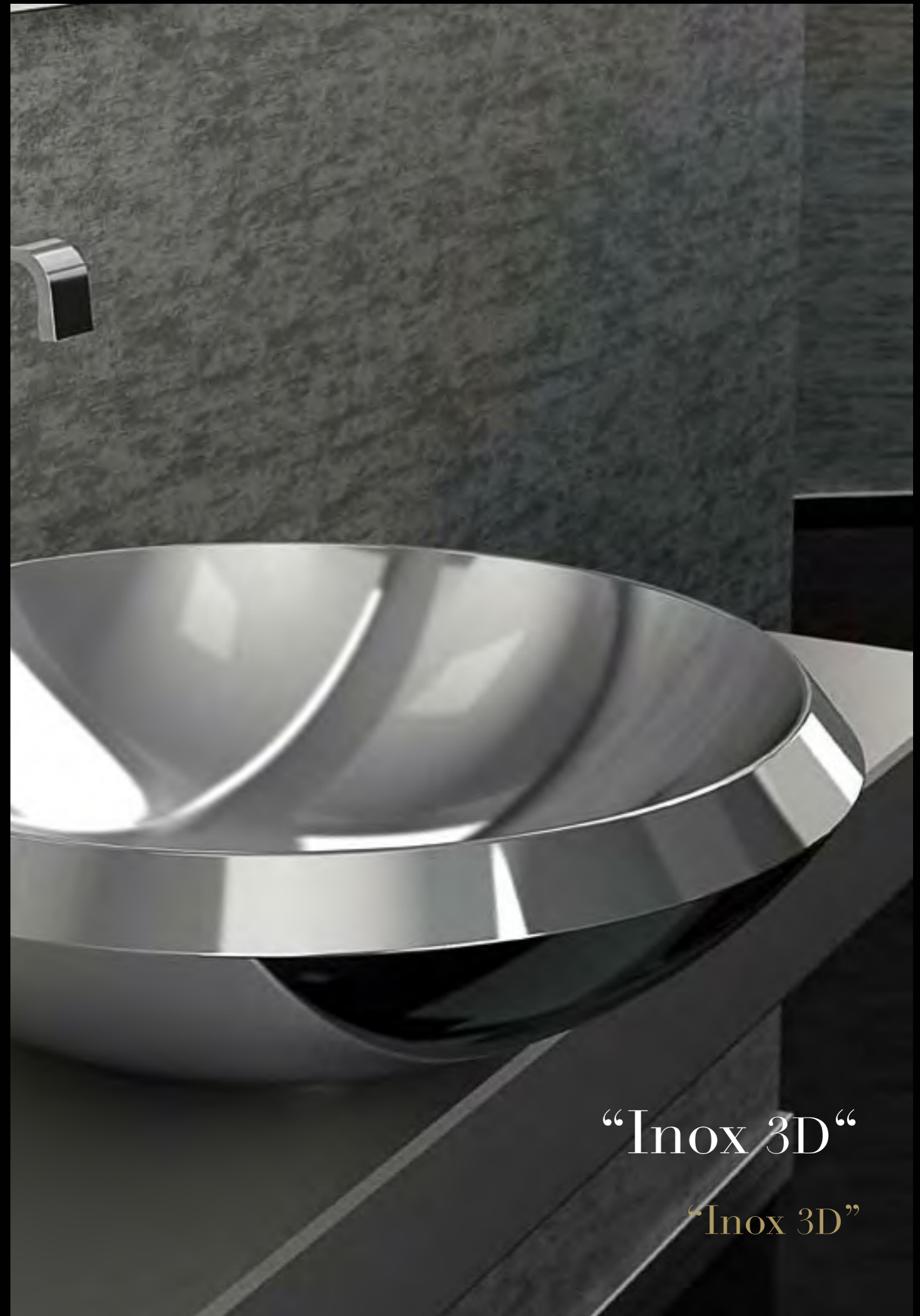

“Inox 3D”

“Inox 3D”



Mito

INOX
ZERO



brevettato / patented

MITO code MITOIL01



MITO code MITOLH33

brevettato / patented



Glo Ball

INOX
ZERO



GLO BALL code GLOBALL01

brevettato / patented



GLO BALL code GLOBALLH36



GLO BALL code GLOBALCB

brevettato / patented



De Coste

INOX
ZERO



DE COSTE code DECOSTEIS01

brevettato / patented



DE COSTE code DECOSTECR



DE COSTE code DECOSTELH33

brevettato / patented



Siliconio®

Il design tattile, morbido, elastico, sensuale.
Touch and feel - soft and sensual.

Siliconio®, ultima generazione della famiglia dei siliconi. Via al design all'insegna dell'elasticità, dalle forme più rigorose che sfruttano le grandi potenzialità di questa materia, a quelle più bizzarre e originali. E' un materiale dalle forti sensazioni tattili: morbido, elastico, sensuale, unico. Siliconio®, quale materiale elastico, può essere sottoposto a torsioni, allungamenti e piegamenti ed in corso di rilascio torna alla sua forma originale. Siliconio® è idrorepellente, antinfortunistico, resistente a temperature tra -60°C e +250°C, lavabile, autoestinguento, atossico, dotato di resistenza chimica eccellente. Siliconio® è Touch design per eccellenza.

Siliconio®, is the latest development in the family of silicone materials. Featuring unique designs based on its elasticity, it allows for rigorous shapes, benefiting from the great potential of the material, being amongst the most unique and original. It is a material of touch: soft, elastic, sensual – simply unique. Siliconio® can be bent and folded in any possible way, always returning to its original form once released. Siliconio®, is water-repellent and, soft, thus reducing the risk of injury, but also resistant to extreme temperatures from -60°C to +250°C, washable, self-extinguishing, non-toxic and with excellent chemical resistance characteristics. Siliconio® is 'Touch design' at its very best.



“Touch design per eccellenza”

“Excellence you can touch and feel”

Barchetta

Siliconiò



BARCETTA LIGHT code BARCHSL34L

brevettato / patented



BARCETTA code BARCHSL32

195

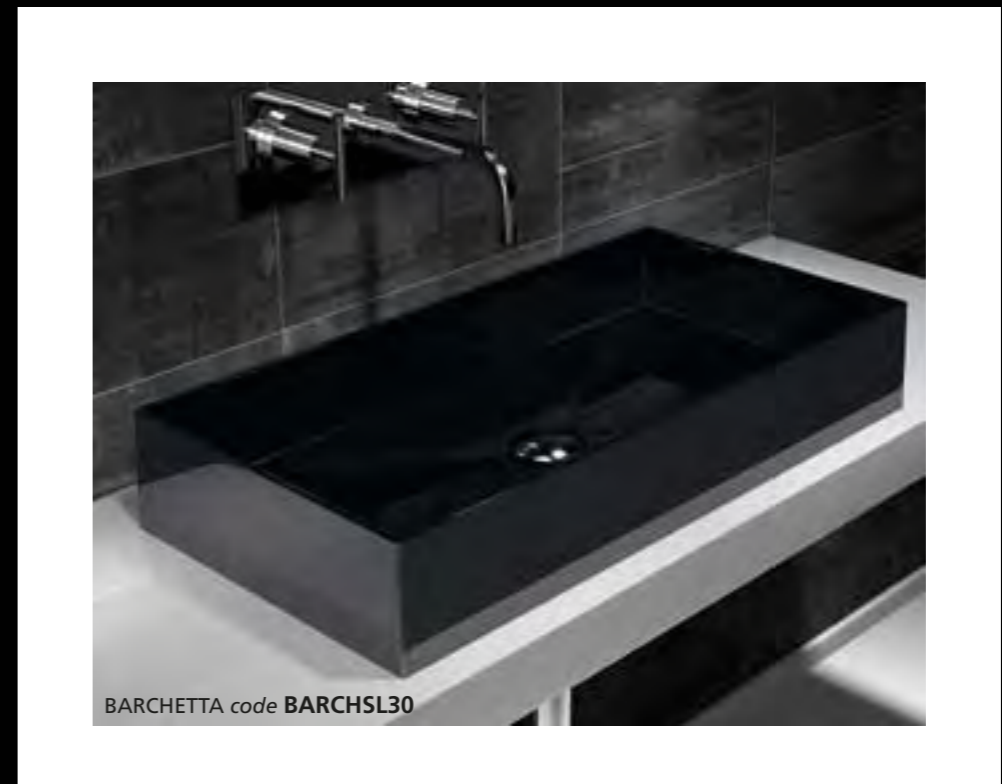

BARCETTA code BARCHSL30

brevettato / patented



Gum

Siliconiò

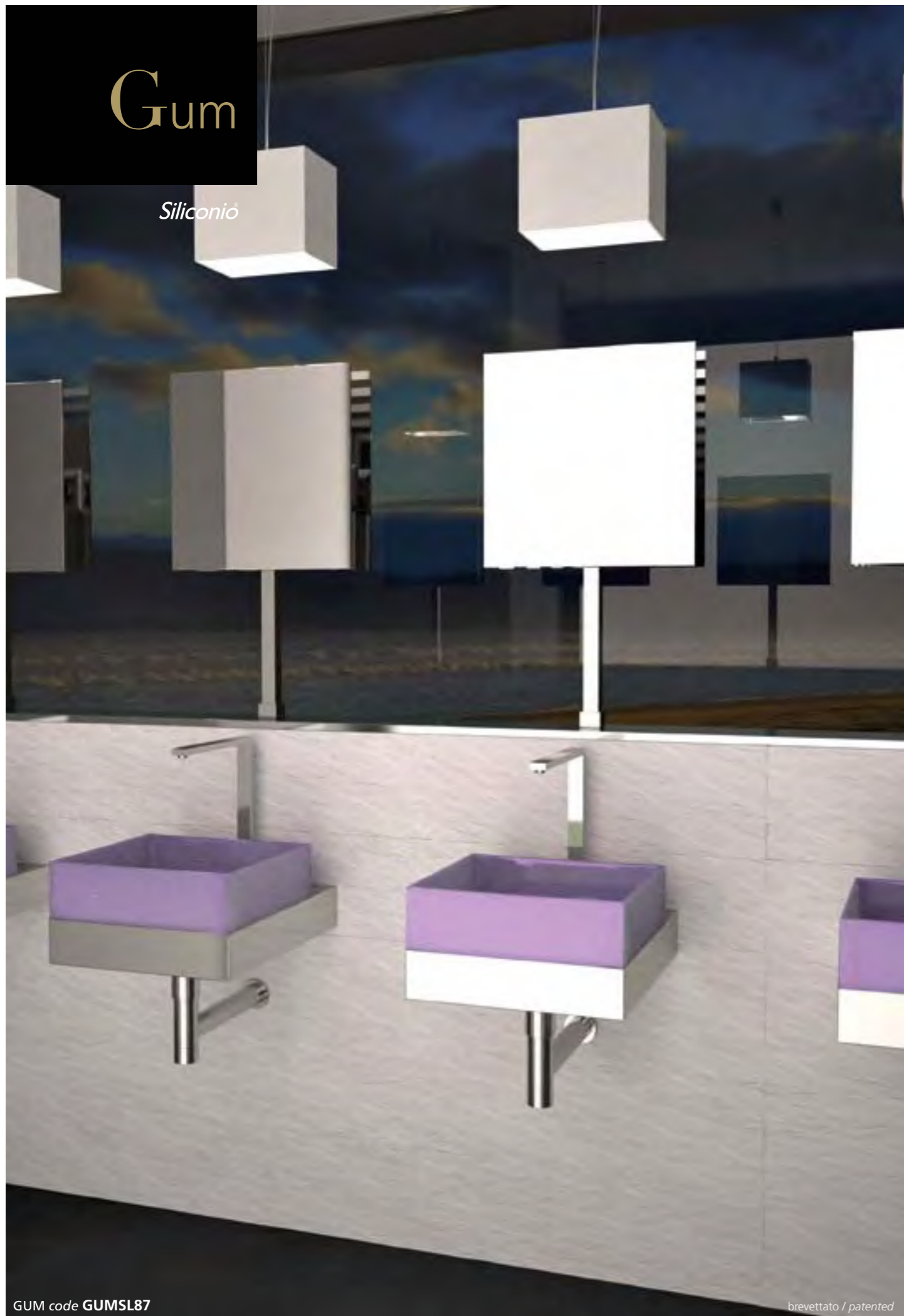

GUM code GUMSL87

brevettato / patented

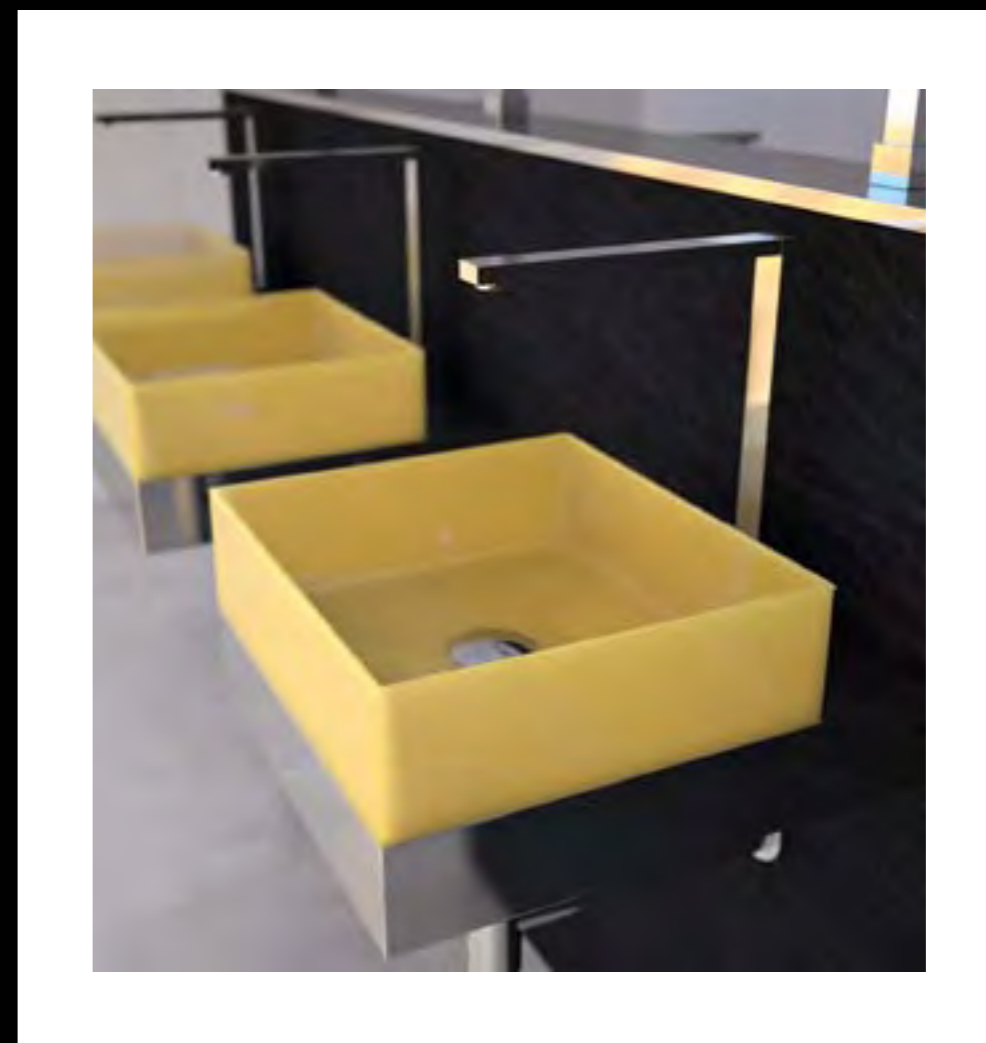

GUM code GUMSL05

brevettato / patented



“accessori”
accessories

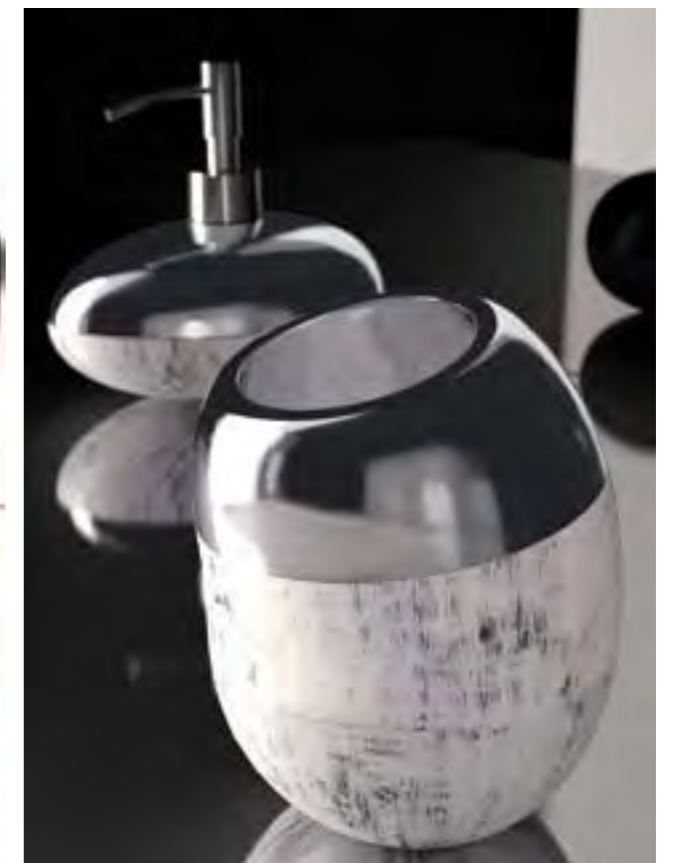

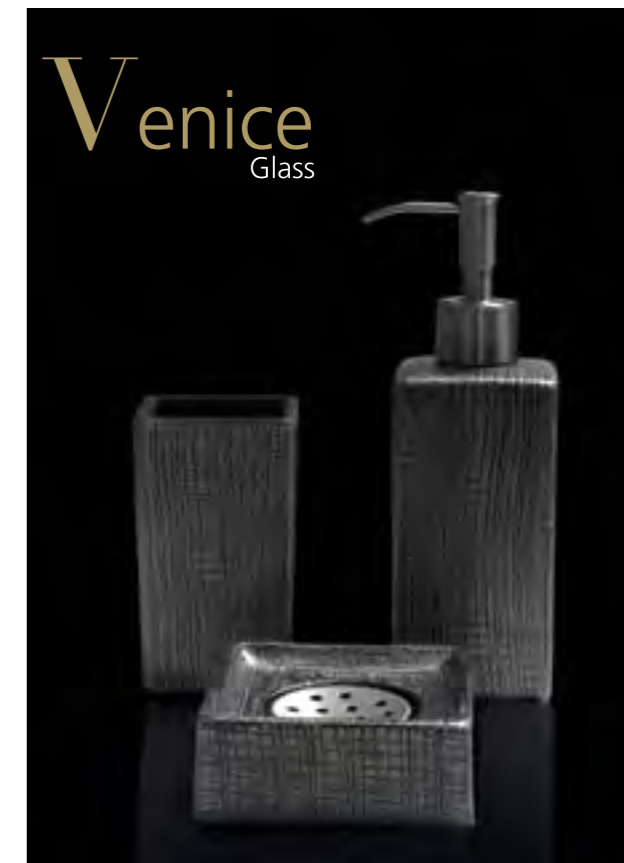

Icissance



code ICESSENCE1T01F3



code ICESSENCE2T01F3

Icissance Luxor



code ICESSENCELUX1T01F3



code ICESSENCELUX2T01F3



Icissance

Collection



Icissance Ice



code ICESSENCEICE1T01F3



code ICESSENCEICE2T01F3

Icissance Ramada



code ICESSENCERAM1T01F3



code ICESSENCERAM2T01F3



SPECIAL ONE

Luxury toilet brush



Opera

Large

Cristallo
DE MEDICI
Pb 24%



Opera LARGE

clear / gold OPERALT01F3



Opera

Cristallo
DE MEDICI
Pb 24%



Opera SMALL
clear / chrome OPERAST01F4



Opera XL
clear / gold OPERAXLT01F3



Canto

Cristallo
DE MEDICI
Pb 24%



Canto SMALL
clear / chrome CANTOST01F4



Canto XL
clear / gold CANTOXLT01F3



“specifiche”
data sheet



Kool
Vetro Freddo

brevettato / patented

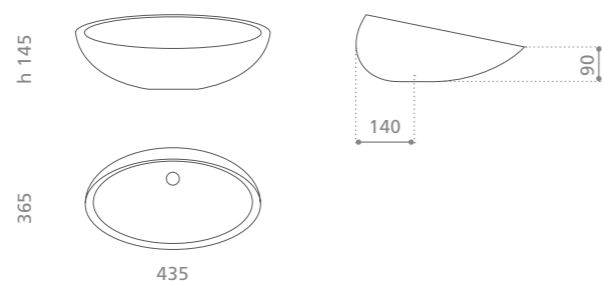

Ø foro / hole = 45 mm
peso / weight = 5,50 kg

code:



code:



Kool max
Vetro Freddo

brevettato / patented

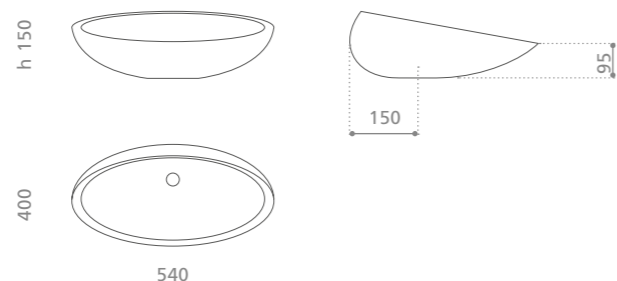

Ø foro / hole = 45 mm
peso / weight = 6,50 kg

code:



code:



Kool XL
Vetro Freddo

brevettato / patented

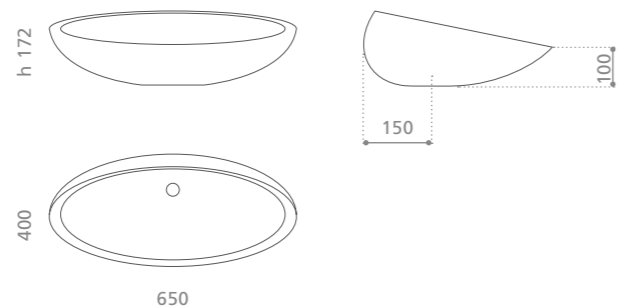

Ø foro / hole = 45 mm
peso / weight = 6,70 kg

code:



code:



Kool oversize

brevettato / patented

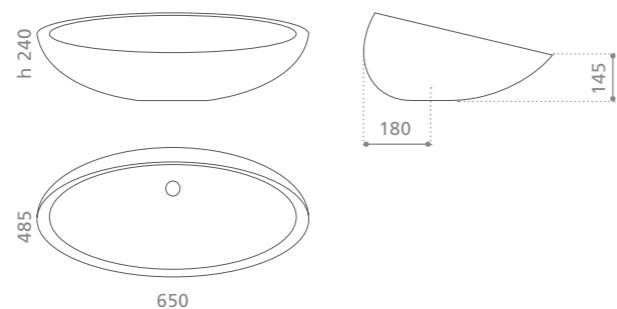

Ø foro / hole = 45 mm
peso / weight = 6,70 kg

code:



code:



Air
Vetro Freddo

brevettato / patented

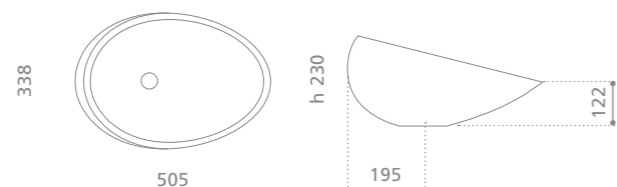

Ø foro / hole = 45 mm
peso / weight = 6,30 kg

code:



code:





Morpheo max

Vetro Freddo

design by:
LUNARDI MENCHINI

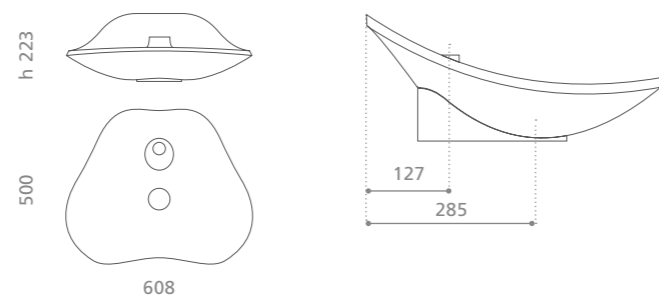

Ø foro / hole = 45 mm
peso / weight = 8,50 kg

Morpheo small

Vetro Freddo

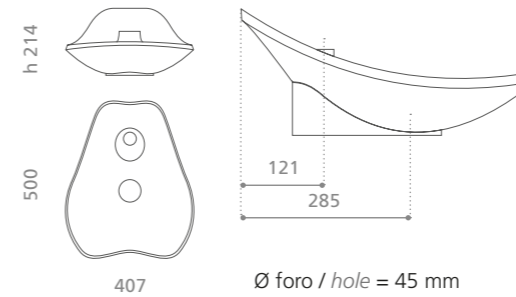

Ø foro / hole = 45 mm
peso / weight = 4,50 kg

code:



white
MOMAXPO01
MOSMALLPO01



black
MOMAXPO30
MOSMALLPO30

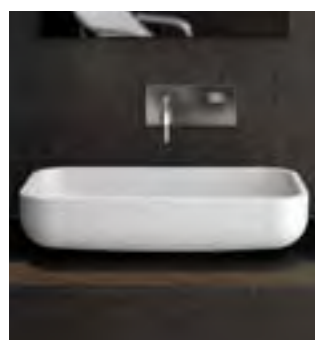

Jimmy

Vetro Freddo

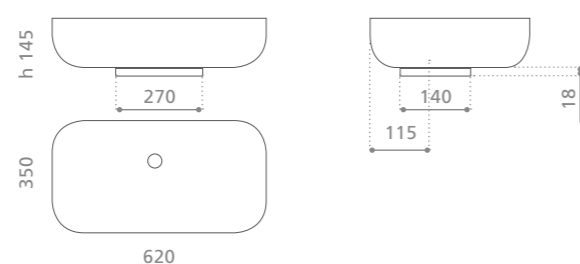

Ø foro / hole = 45 mm
peso / weight = 11,50 kg

code:



white
JIMMYPO01



black
JIMMYPO30



white gloss
JIMMYPL01



black gloss
JIMMYPL30



cognac
JIMMYTO35



Net

Vetro Freddo

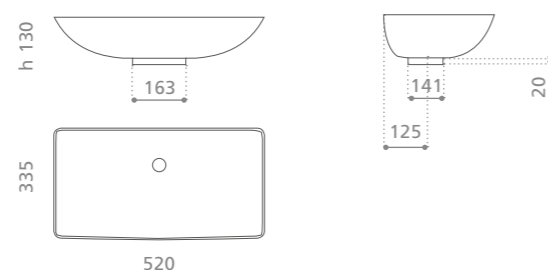

Ø foro / hole = 45 mm
peso / weight = 4,50 kg

code:



white
NETPO01



black
NETPO30



cognac
NETTO35



red mat
NETTO34



bluemarine
NETTO02



green mat
NETTO32



Stone

Vetro Freddo

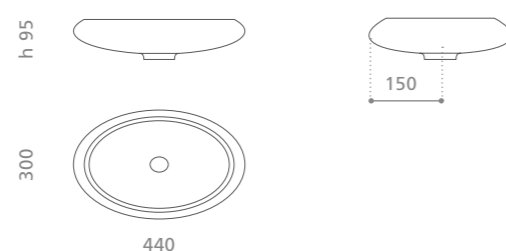

Ø foro / hole = 45 mm
peso / weight = 2,50 kg

code:



white
STONEPO01



black
STONEPO30



moka
STONEPO33



cognac
STONETO35



red mat
STONETO34



bluemarine
STONETO02

“Collezione d’arte futurista”
“The avant-garde collection”

Leggerezza e design sposano la tecnologia.
Light weight, spectacular design, innovative technology.



FLOWer
Pert[®]
design by:
MARCO PISATI

brevettato / patented

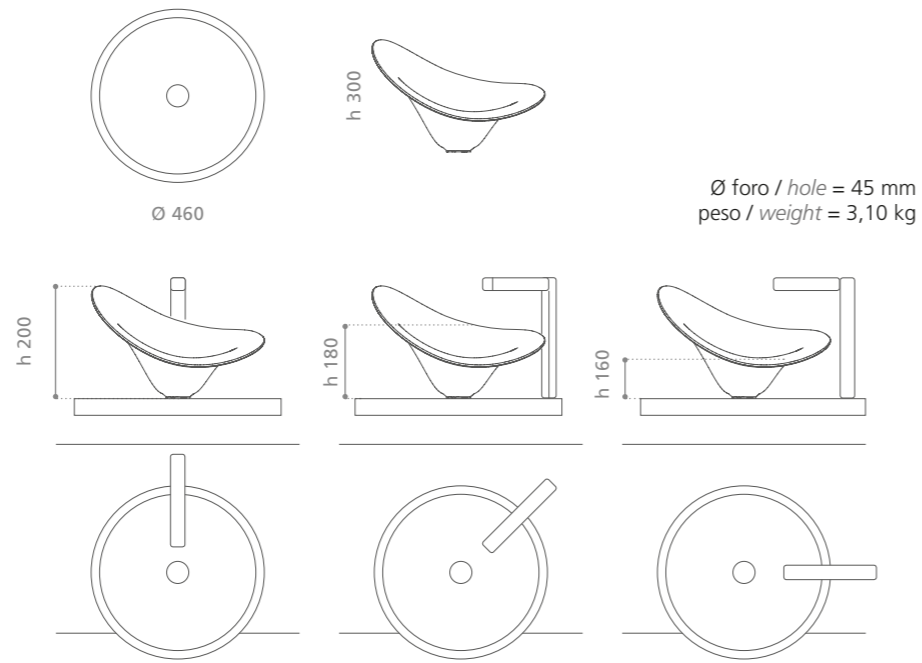

code:

white mat
FLOP31

white gloss
FLO401

black mat
FLOP30

black gloss
FLO402



code:

platinum
FLOPL

Ferrari red
FLOPL34

silver leaf 3d
FLOFA

gold leaf 3d
FLOFO



Rho metal
Pert[®]

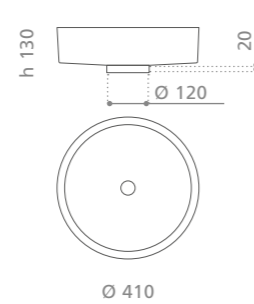

$\varnothing \text{ foro / hole} = 45 \text{ mm}$
 $\text{peso / weight} = 4,65 \text{ kg}$

code:

brushed gold
RHOGD

brushed platinum
RHOPL

brushed dark inox
RHODI

brushed copper
RHOCP



Rho lux
Pert[®]

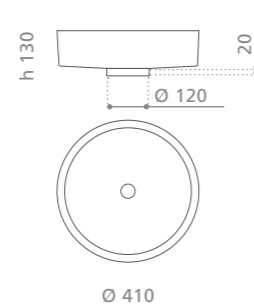

$\varnothing \text{ foro / hole} = 45 \text{ mm}$
 $\text{peso / weight} = 4,65 \text{ kg}$

code:

silver leaf 3d
RHOFA

gold leaf 3d
RHOFO



**Rho
starlight**
Pert[®]

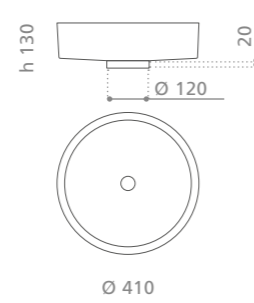

Ø foro / hole = 45 mm
peso / weight = 4,65 kg

code:



white starlight
RHOH01



black starlight
RHOH30



grey starlight
RHOH43



champagne starlight
RHOH05



**Rho
vision**
Pert[®]

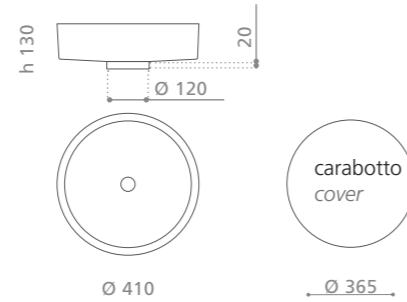

Ø foro / hole = 45 mm
peso / weight = 6,15 kg

code:



white mat
RHOBO



black mat
RHONO



**Four
lux**
Pert[®]

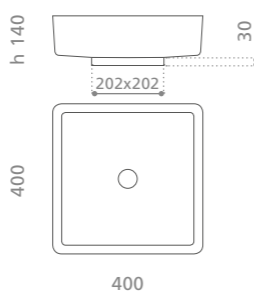

Ø foro / hole = 45 mm
peso / weight = 4,65 kg

code:



silver leaf 3d
FOURFA



gold leaf 3d
FOURFO



**Four
starlight**
Pert[®]

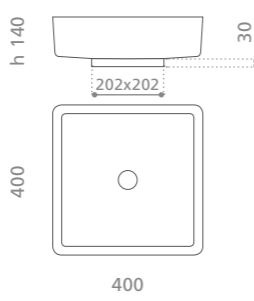

Ø foro / hole = 45 mm
peso / weight = 4,65 kg

code:



white starlight
FOURLH01



black starlight
FOURLH30



grey starlight
FOURLH43



champagne starlight
FOURLH05



**Four
vision**
Pert[®]

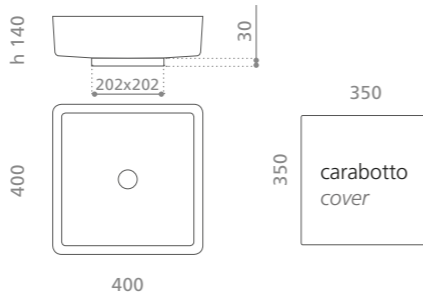

Ø foro / hole = 45 mm
peso / weight = 6,14 kg

code:



white mat
FOURBO



black mat
FOURNO



Blade vision
Pert[®]

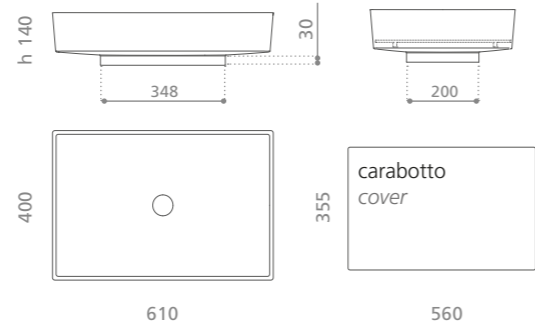

Ø foro / hole = 45 mm
peso / weight = 8,50 kg

code:



white mat
BLADEBO



black mat
BLADENO

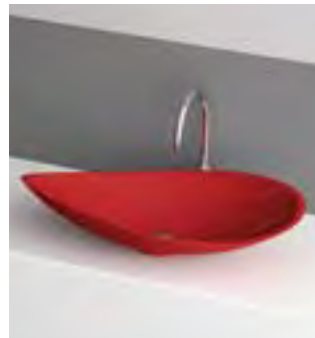

Infinity colour
Pert[®]
design by:
MOGIODESIGN

brevettato / patented

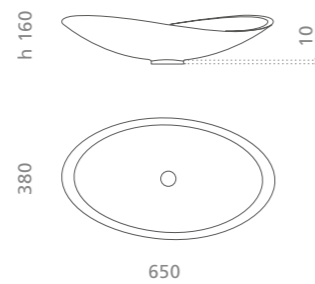

Ø foro / hole = 45 mm
peso / weight = 3,30 kg

code:



white gloss
INFINITY401



black gloss
INFINITY402



Ferrari red
INFINITYPL34



melanzana
INFINITY807



plum
INFINITY802



acid green
INFINITY404



Infinity starlight
Pert[®]
design by:
MOGIODESIGN

brevettato / patented

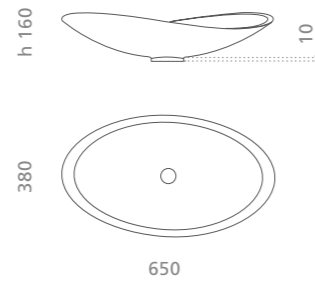

Ø foro / hole = 45 mm
peso / weight = 3,30 kg

code:



white starlight
INFINITYLH01



black starlight
INFINITYLH30



grey starlight
INFINITYLH43



champagne starlight
INFINITYLH05



blue starlight
INFINITYLH18



Open
Pert[®]

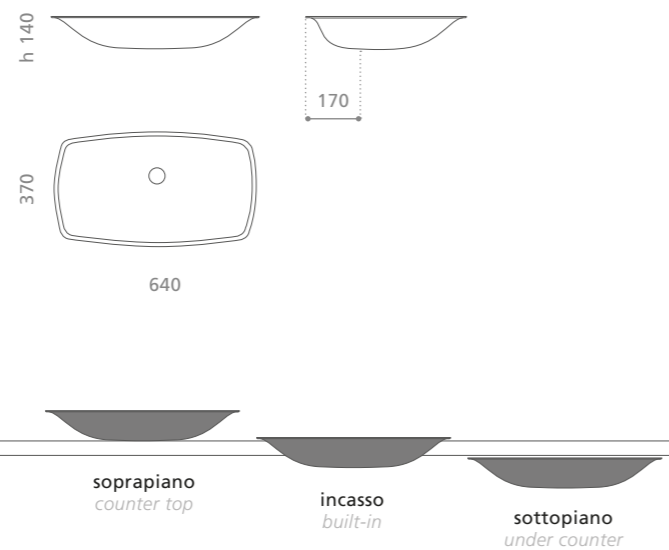

Ø foro / hole = 45 mm
peso / weight = 3,50 kg

code:



white gloss
OPEN401



black gloss
OPEN402



beige
OPEN406



grey
OPEN407



glicine
OPEN802



alice blue
OPEN403



marine
OPEN405



azzurro
OPEN806



green apple
OPEN803



melanzana
OPEN807



acid green
OPEN404



yellow
OPEN805



orange
OPEN804



Ferrari red
OPENPL34



Cocoon
TeknoForm®

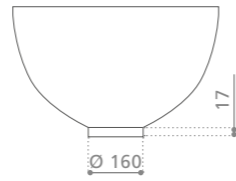
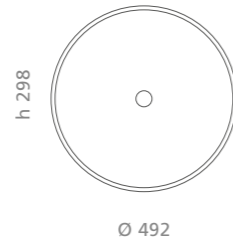

Ø foro / hole = 45 mm
peso / weight = 7,00 kg

code:



white
COCOONPO01



brushed gold - white
COCOONGDW



brushed platinum - white
COCOONPLW



brushed dark inox - white
COCOONDIW



Cocoon Lux
TeknoForm®

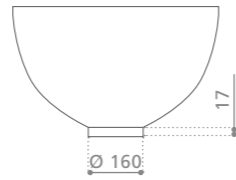
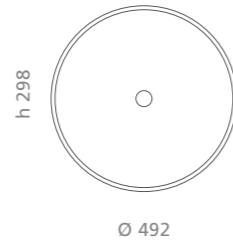

Ø foro / hole = 45 mm
peso / weight = 7,00 kg

code:



gold leaf 3d
COCOONFO



silver leaf 3d
COCOONFA



Mosaic
TeknoForm®

brevettato / patented

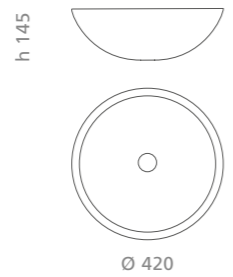

Ø foro / hole = 45 mm
peso / weight = 6,00 kg

code:



white
MOSAICPO01



black
MOSAICPO30



silver leaf 3d
MOSAICFA



gold leaf 3d
MOSAICFO



copper leaf 3d
MOSAICFR



platinum
MOSAICPL



Circus 50
TeknoForm®

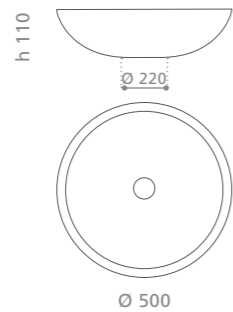

Ø foro / hole = 45 mm
peso / weight = 9,00 kg

code:



white
CIRCUS50PO01



black
CIRCUS50PO30



silver leaf 3d
CIRCUS50FA



gold leaf 3d
CIRCUS50FO



copper leaf 3d
CIRCUS50FR



platinum
CIRCUS50PL



Circus 43
TeknoForm®

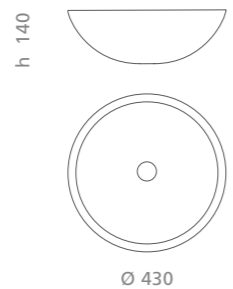

Ø foro / hole = 45 mm
peso / weight = 7,00 kg

code:



white
CIRCUS43PO01



black
CIRCUS43PO30



silver leaf 3d
CIRCUS43FA



gold leaf 3d
CIRCUS43FO



copper leaf 3d
CIRCUS43FR



platinum
CIRCUS43PL



Circus 43
travertino
TeknoForm®

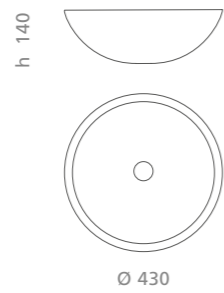

Ø foro / hole = 45 mm
peso / weight = 7,00 kg

code:



white travertino
CIRCUS43ST01



black travertino
CIRCUS43ST30



natural travertino
CIRCUS43ST31

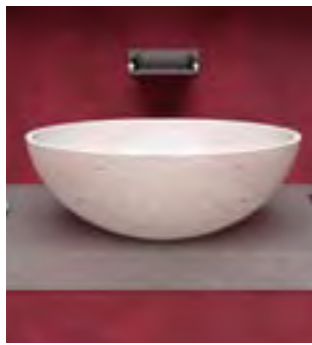

Oval
travertino
TeknoForm®

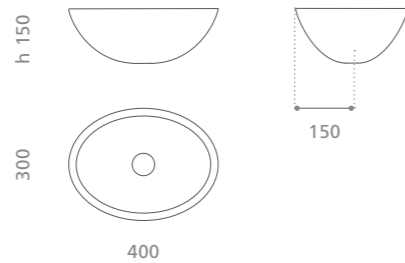

Ø foro / hole = 45 mm
peso / weight = 5,80 kg

code:



white travertino
OVALST01



black travertino
OVALST30



natural travertino
OVALST31

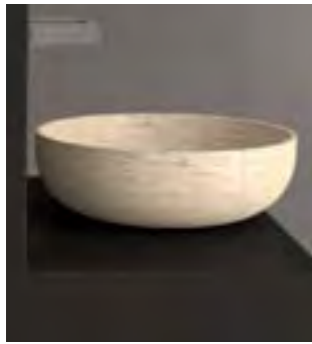

Rapolano
TeknoForm®
brevettato / patented

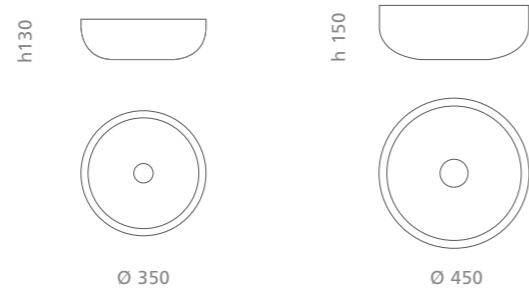

RAPOLANO 35
Ø foro / hole = 35 mm
peso / weight = 5,50 kg

RAPOLANO 45
Ø foro / hole = 45 mm
peso / weight = 10,80 kg

code:



natural travertino
RAP35ST



white travertino
RAP35B



anthracite travertino
RAP35N



cotto
RAP35TC



natural travertino
RAP45ST



white travertino
RAP45B



anthracite travertino
RAP45N



cotto
RAP45TC



Modo
small
TeknoForm®

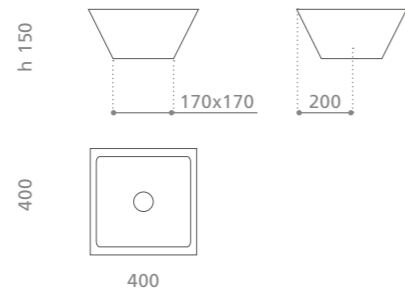

Ø foro / hole = 45 mm
peso / weight = 10,00 kg

code:



white
MODOSMALLPO01



brushed gold / white
MODOSMALLGDW



brushed dark inox / white
MODOSMALLDIW



brushed platinum / white
MODOSMALLPLW



Modo
max
TeknoForm®

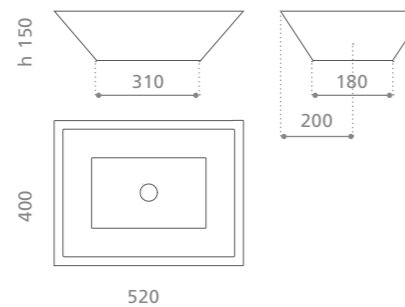

Ø foro / hole = 45 mm
peso / weight = 12,00 kg

code:



white
MODOMAXPO01



brushed gold / white
MODOMAXGDW



brushed dark inox / white
MODOMAXDIW



brushed platinum / white
MODOMAXPLW



Yacht
TeknoForm®

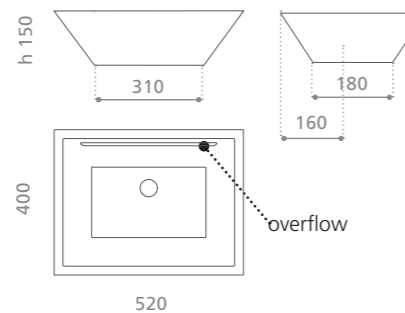

Ø foro / hole = 45 mm
peso / weight = 12,00 kg

code:



white
YACHTPO01





Roma

TeknoForm®

design by:
CAIROLI-DONZELLI

brevettato / patented

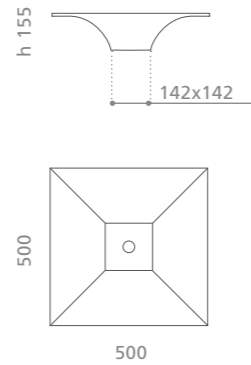

Ø foro / hole = 45 mm
peso / weight = 7,20 kg

code:



white gloss
ROMAPL01

black
ROMAPO30

Ferrari red
ROMAPL34

beige
ROMABG



grey
ROMAGR

tortora
ROMATR

gold leaf
ROMAFO

silver leaf
ROMAFA

code:

Alumix®

lega d'alluminio

“L'espressione dell'Art-Tech”
“The expression of Art-Tech”

L'hi-tech, elegante e contemporaneo.
Distinguishing with contemporary elegance.



Exté

Lux
Alumix

brevettato / patented

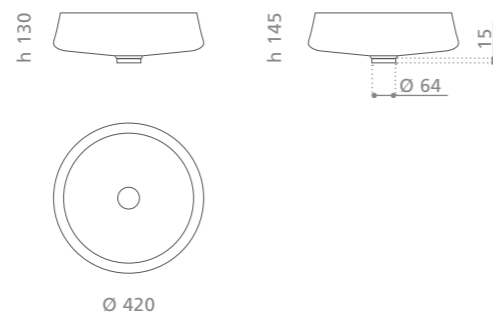

Ø foro / hole = 45 mm
peso / weight = 3,20 kg

code:



white / gold
ALUEXTELWG

white / silver
ALUEXTELWS

black / gold
ALUEXTELBG

black / silver
ALUEXTELBS



Exté

Alumix

brevettato / patented

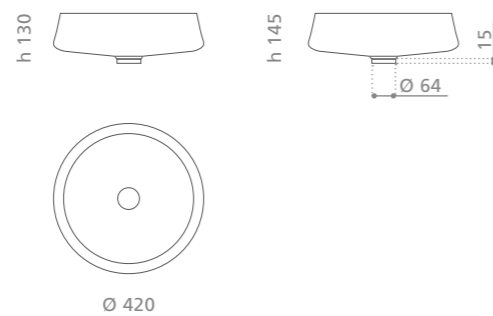

Ø foro / hole = 45 mm
peso / weight = 3,20 kg

code:



white / silver
ALUEXTETA05

black / silver
ALUEXTETA02

brown / black
ALUEXTETA03



Nek

Lux
Alumix

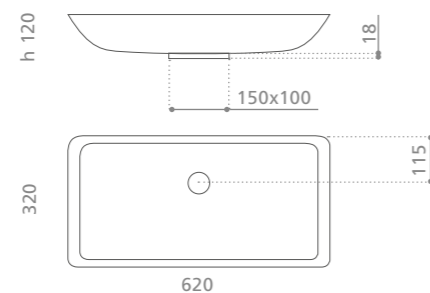

Ø foro / hole = 45 mm
peso / weight = 4,10 kg

code:



white / gold
ALUNEKLWG

white / silver
ALUNEKLWS

black / gold
ALUNEKLBG

black / silver
ALUNEKLBS





Nek
Alumix

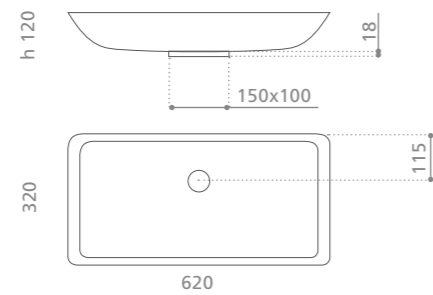

Ø foro / hole = 45 mm
peso / weight = 4,10 kg

code:



white / silver
ALUNEKTA05

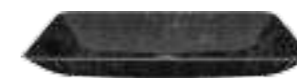

black / silver
ALUNEKTA02



brown / black
ALUNEKTA03



Ares
Alumix

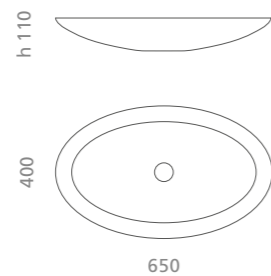

Ø foro / hole = 45 mm
peso / weight = 7,20 kg

code:



white / black
ALUARESA07



black / silver
ALUARESA02



white / copper
ALUARESA08



Round
Alumix

brevettato / patented

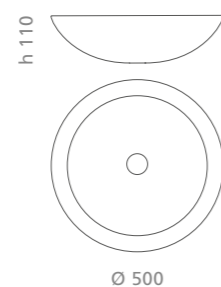

Ø foro / hole = 45 mm
peso / weight = 4,60 kg

code:



white / silver
ALUROA05



black / silver
ALUROA02



red / black
ALUROA04



brown / black
ALUROA03



Vogue
Alumix

brevettato / patented

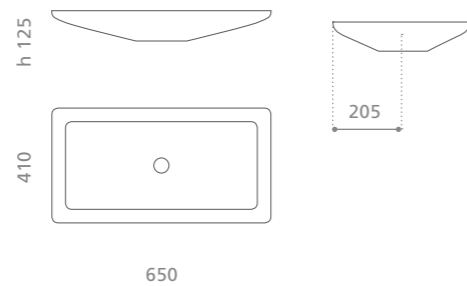

Ø foro / hole = 45 mm
peso / weight = 7,70 kg

code:



white / silver
ALUVOA05



black / silver
ALUVOA02



brown / black
ALUVOA03



Calla

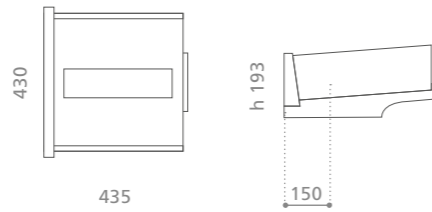

Ø foro / hole = 45 mm
peso / weight = 9,20 kg

code:

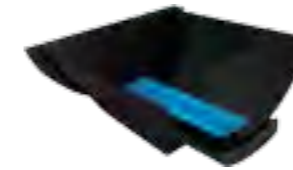

black - bluemarine
CALLABB

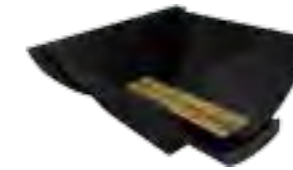

black - gold
CALLABG



black - silver
CALLABS

Supporto in VetroFreddo nero incluso
VetroFreddo black basement included



Calla

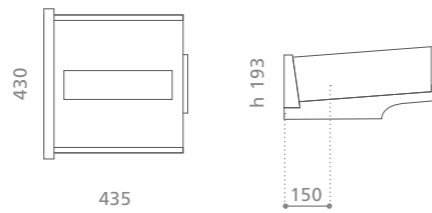

Ø foro / hole = 45 mm
peso / weight = 9,20 kg

code:



calla decor
CALLACR01

Supporto in VetroFreddo bianco incluso
VetroFreddo white basement included



Laguna
Vintage

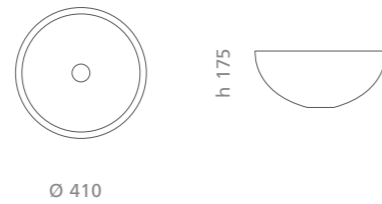

Ø foro / hole = 45 mm
peso / weight = 5,40 kg

code:



red vintage
LAGUNAVN

Base anello cromata e pileta inclusi
Chromed waste and ring basement included

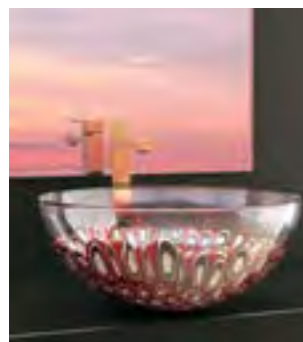

Laguna
rossa

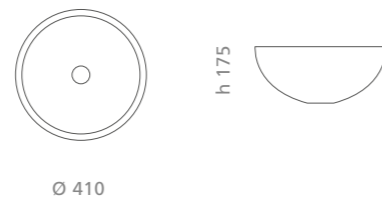

Ø foro / hole = 45 mm
peso / weight = 6,10 kg

code:



red murrine
LAGUNARO

Base anello cromata e pileta inclusi
Chromed waste and ring basement included



Laguna
Oro

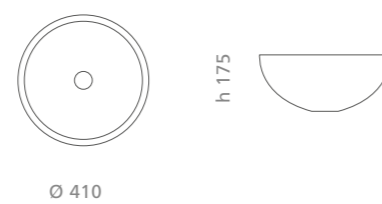

Ø foro / hole = 45 mm
peso / weight = 6,30 kg

code:



gold
LAGUNAGD

Base anello cromata e pileta inclusi
Chromed waste and ring basement included



Laguna Night

made with MURANO® glass

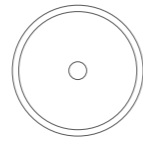

Ø 410

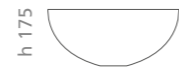

h 175

Ø foro / hole = 45 mm
peso / weight = 4,70 kg

code:



brown
LAGUNAT33

Base anello cromata e piletta inclusi
Chromed waste and ring basement included



Laguna Red

made with MURANO® glass

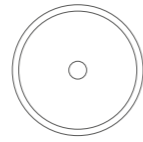

Ø 410

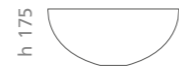

h 175

Ø foro / hole = 45 mm
peso / weight = 4,70 kg

code:



red transparent
LAGUNAT16

Base anello cromata e piletta inclusi
Chromed waste and ring basement included



Laguna Smoke

made with MURANO® glass

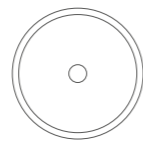

Ø 410



h 175

Ø foro / hole = 45 mm
peso / weight = 4,70 kg

code:



smoke transparent
LAGUNAT43

Base anello cromata e piletta inclusi
Chromed waste and ring basement included



Laguna Blue

made with MURANO® glass

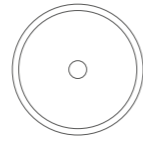

Ø 410



h 175

Ø foro / hole = 45 mm
peso / weight = 4,70 kg

code:



blue transparent
LAGUNAT42

Base anello cromata e piletta inclusi
Chromed waste and ring basement included



Canale

made with MURANO® glass

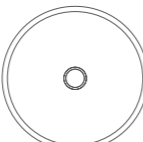

Ø ± 370



h ± 210

Ø foro / hole = 45 mm
peso / weight = 6,40 kg

code:



white / black
CANALEWB

Base anello cromata e piletta inclusi
Chromed waste and ring basement included



Ottico

made with MURANO® glass

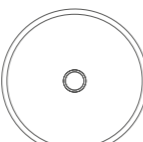

Ø ± 370



h ± 210

Ø foro / hole = 45 mm
peso / weight = 6,40 kg

code:



grey / white
OTTICOGW

Base anello cromata e piletta inclusi
Chromed waste and ring basement included



I colori rappresentati in stampa si intendono puramente indicativi. - Print colors of the wash basins may vary slightly from original color.



Gondola

made with
MURANO[®]
glass

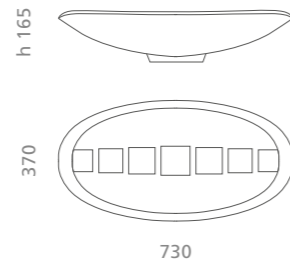

Ø foro / hole = 45 mm
peso / weight = 6,60 kg

code:



gondola decor
GONDOLATX01

Supporto in VetroFreddo nero e piletta inclusi
VetroFreddo black basement and chromed waste included

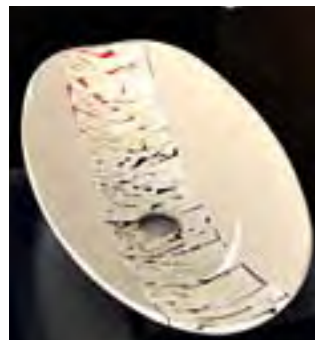

Carnival

made with
MURANO[®]
glass

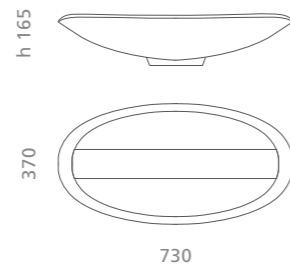

Ø foro / hole = 45 mm
peso / weight = 6,60 kg

code:



carnival decor
CARNIVALCR01

Supporto in VetroFreddo nero e piletta inclusi
VetroFreddo black basement and chromed waste included



Gondola Spring

made with
MURANO[®]
glass

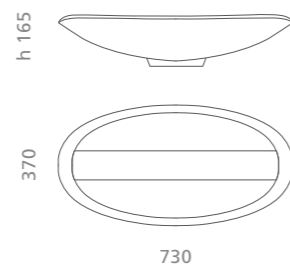

Ø foro / hole = 45 mm
peso / weight = 6,60 kg

code:



gondola spring decor
GONDOLASPR01

Supporto in VetroFreddo nero e piletta inclusi
VetroFreddo black basement and chromed waste included



Glo Ball Murano

made with
MURANO[®]
glass

brevettato / patented

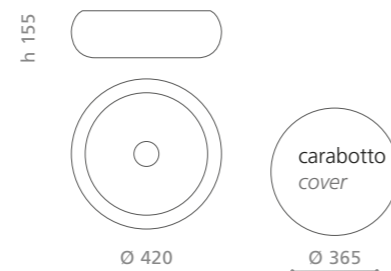

Ø foro / hole = 45 mm
peso / weight = 5,20 kg

code:



amber
GLOBALLMT05



smoke
GLOBALLMT43



cognac
GLOBALLMT33



opal white
GLOBALLMT36



*black mat cover
in Pert[®]*
INCLUDED



*black mat cover
in Pert[®]*
INCLUDED



*black mat cover
in Pert[®]*
INCLUDED



*white mat cover
in Pert[®]*
INCLUDED

Base anello cromata e piletta inclusi
Chromed waste and ring basement included

Realizzato a mano da maestri vetrai muranesi secondo le più rinomate tradizioni.
Eventuali piccole imperfezioni e variazioni di forma e colore sono testimonianza dell'artigianalità del processo produttivo.
Handmade by master glassmakers of Murano according to the most ancient and noble glass arts.
Any slight imperfections and variations in shape and colour highlight the craftsmanship of the production process.

“Il Cristallo: collezioni d'arte”
“The Crystal: art collections”

Dalle più antiche e nobili arti vetrarie.
From the ancient and noble glass arts.



Collier
Cristallo DE' MEDICI Pb 24%

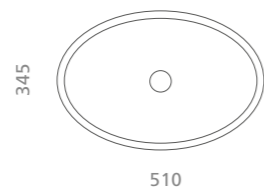

Ø foro / hole = 45 mm
peso / weight = 7,35 kg



black / clear collar
COLLIERT30

code:



Ice Oval
Cristallo DE' MEDICI Pb 24%

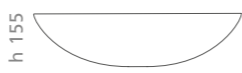
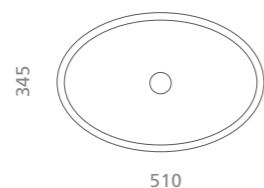

Ø foro / hole = 45 mm
peso / weight = 6,80 kg



clear
ICEOVT01

code:

Base anello cromata e piletta inclusi Chromed waste and ring basement included



Ice Oval Lux
Cristallo DE' MEDICI Pb 24%

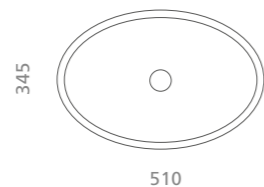

Ø foro / hole = 45 mm
peso / weight = 6,80 kg



silver
ICEOVSLF4

code:



gold
ICEOVGDF3



platinum
ICEOVPLF4



gold pink
ICEOVPGF4

Base anello e piletta inclusi Waste and ring basement included



Ice Round
Cristallo DE' MEDICI Pb 24%

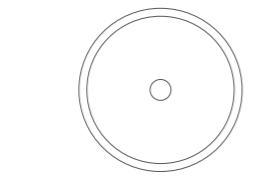

Ø foro / hole = 45 mm
peso / weight = 6,20 kg



clear
ICEROT01

code:

Base anello cromata e piletta inclusi Chromed waste and ring basement included



Luxor Oval
Cristallo DE' MEDICI Pb 24%

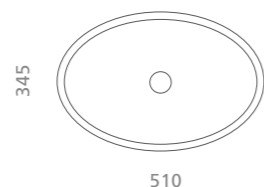

Ø foro / hole = 45 mm
peso / weight = 6,80 kg

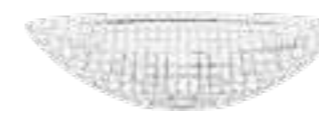

clear
LUXOROV01

code:

Base anello cromata e piletta inclusi Chromed waste and ring basement included



Luxor Round
Cristallo DE' MEDICI Pb 24%

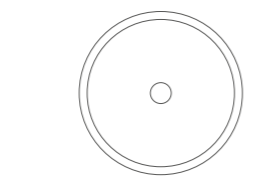

Ø foro / hole = 45 mm
peso / weight = 6,20 kg



clear
LUXORROT01

code:

Base anello cromata e piletta inclusi Chromed waste and ring basement included

“Il Cristallo: collezioni d’arte”
“The Crystal: art collections”

Dalle più antiche e nobili arti vetrarie.
From the ancient and noble glass arts.



Moon
Cristallo DE' MEDICI Pb 24%
brevettato / patented

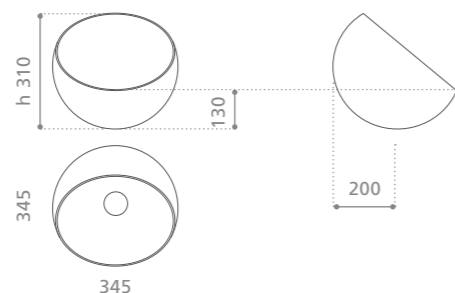

Ø foro / hole = 45 mm
peso / weight = 8,90 kg

code:



clear
MOONT01

Base anello cromata e piletta inclusi
Chromed waste and ring basement included

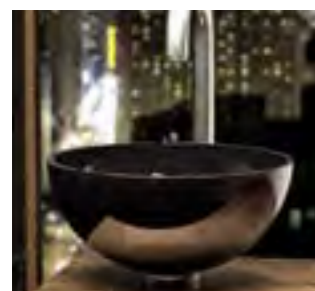

Chelo
Cristallo DE' MEDICI Pb 24%



Ø foro / hole = 45 mm
peso / weight = 7,50 kg

code:



clear
CHELOT01



black
CHELOT30



Clivia
Cristallo DE' MEDICI Pb 24%

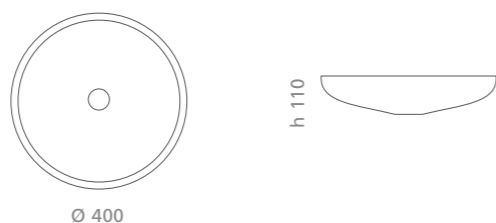

Ø foro / hole = 45 mm
peso / weight = 6,70 kg

code:



clear
CLIVIAT01



black
CLIVIAT35



Marinus
Cristallo DE' MEDICI Pb 24%

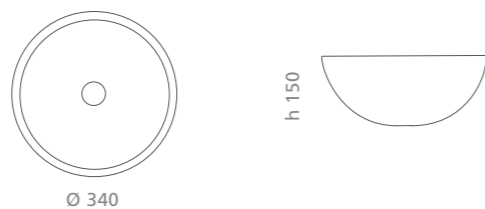

Ø foro / hole = 45 mm
peso / weight = 7,50 kg

code:



clear
MARINUST01



Ramada
Cristallo DE' MEDICI Pb 24%

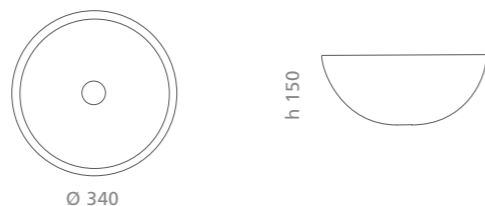

Ø foro / hole = 45 mm
peso / weight = 7,50 kg

code:



clear
RAMADAT01



Aqua
Cristallo DE' MEDICI Pb 24%

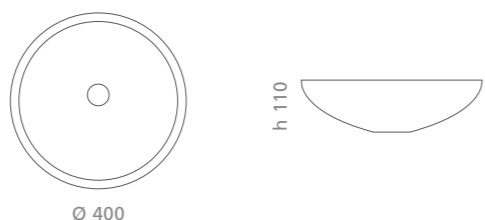

Ø foro / hole = 45 mm
peso / weight = 6,70 kg

code:



clear
AQUAT01



black
AQUAT30



Moon Over Ice



brevettato / patented

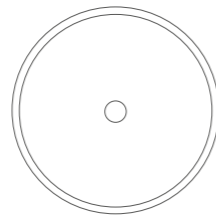

Ø 395

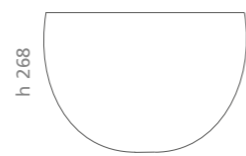

h 268

Ø foro / hole = 45 mm
peso / weight = 6,90 kg

code:



clear
MOONOVICET01

Base anello cromata e piletta inclusi
Chromed waste and ring basement included



Glo Ball Crystal Ice



brevettato / patented

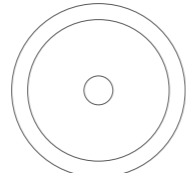

Ø 445



h 180

Ø foro / hole = 45 mm
peso / weight ± 7,10 kg

code:



clear
GLOBALLICET01

Base anello cromata e piletta inclusi
Chromed waste and ring basement included



Glo Ball Crystal Ramada



brevettato / patented

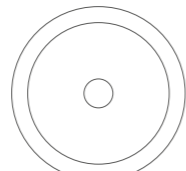

Ø 445



h 180

Ø foro / hole = 45 mm
peso / weight ± 8,20 kg

code:



clear
GLOBALLRAMT01

Base anello cromata e piletta inclusi
Chromed waste and ring basement included

Florence Glass ATELIER®

“Collezioni esclusive
dal mondo della moda”
L'ultima tendenza di oggetti decorati a mano.

“Exclusive collection inspired
by the fashion world”
Avant-garde trends in artisan product design.



Venice 40

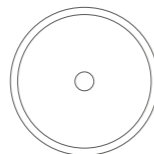

Ø 400



h 150

Ø foro / hole = 45 mm
peso / weight = 4,30 kg

code:



gold / silver
VENICE40OA



silver / black
VENICE40AN



brown / ivory
VENICE40MA



Venice 44

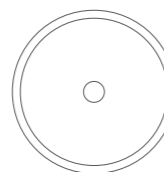

Ø 440



h 150

Ø foro / hole = 45 mm
peso / weight = 5,20 kg

code:



gold / silver
VENICE44OA



silver / black
VENICE44AN



brown / ivory
VENICE44MA





Graffiti
34
Florence Glass
ATELIER



h 125

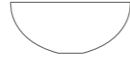

Ø foro / hole = 45 mm
peso / weight = 3,10 kg

code:



red - gold - ivory
GRAFFITI34RG



black - gold - ivory
GRAFFITI34BG



Graffiti
40
Florence Glass
ATELIER

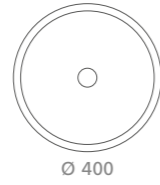

h 150



Ø foro / hole = 45 mm
peso / weight = 4,30 kg

code:



red - gold - ivory
GRAFFITI40RG



black - gold - ivory
GRAFFITI40BG



Graffiti
44
Florence Glass
ATELIER

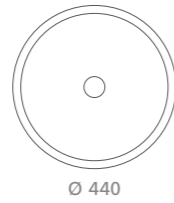

h 150



Ø foro / hole = 45 mm
peso / weight = 5,20 kg

code:



red - gold - ivory
GRAFFITI44RG



black - gold - ivory
GRAFFITI44BG



Luna 40
Florence Glass
ATELIER

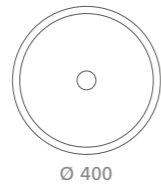

h 150



Ø foro / hole = 45 mm
peso / weight = 4,50 kg

code:



white
LUNA40WT



grey
LUNA40GR



sand
LUNA40SN



yellow
LUNA40YL

brevettato / patented

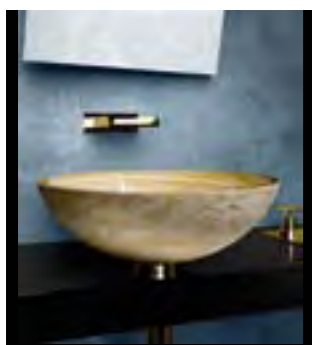

Luna 44
Florence Glass
ATELIER

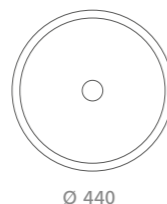

h 150



Ø foro / hole = 45 mm
peso / weight = 5,60 kg

code:



white
LUNA44WT



grey
LUNA44GR



sand
LUNA44SN



yellow
LUNA44YL

brevettato / patented



Luna 45
Florence Glass
ATELIER

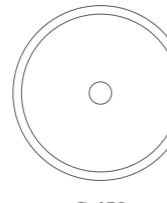

h 170



Ø foro / hole = 45 mm
peso / weight = 6,60 kg

code:



white
LUNA45WT



grey
LUNA45GR



sand
LUNA45SN



yellow
LUNA45YL

brevettato / patented





Luna Forma small

Florence Glass
ATELIER

brevettato / patented

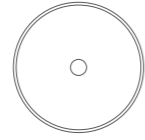

Ø 299

h 140



Ø foro / hole = 45 mm
peso / weight = 3,70 kg

code:



white
FORMASLWT



grey
FORMASLGR



sand
FORMASLSN



yellow
FORMASLYL



Luna Forma

Florence Glass
ATELIER

brevettato / patented



Ø 399

h 180



Ø foro / hole = 45 mm
peso / weight = 5,60 kg

code:



white
FORMALWT



grey
FORMALGR



sand
FORMALSN



yellow
FORMALYL

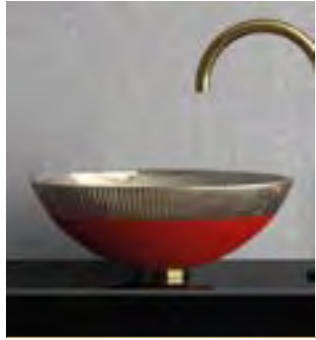

Luna katino

Florence Glass
ATELIER

brevettato / patented

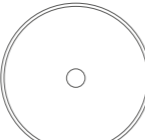

Ø 399

h 146



Ø foro / hole = 45 mm
peso / weight = 3,60 kg

code:



white
KATINOLWT



grey
KATINOLGR



sand
KATINOLSN



yellow
KATINOLYL



Filigrana 34

Florence Glass
ATELIER

brevettato / patented

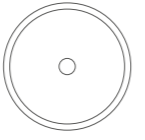

Ø 340

h 125



Ø foro / hole = 45 mm
peso / weight = 3,10 kg

code:



red / gold
FILIGRANA34RG



white / gold
FILIGRANA34WG



gold leaf / white
FILIGRANA34FOW



black / silver
FILIGRANA34BS



silver leaf / black
FILIGRANA34FAB



Filigrana 40

Florence Glass
ATELIER

brevettato / patented

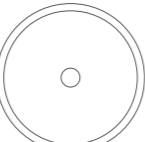

Ø 400

h 150



Ø foro / hole = 45 mm
peso / weight = 4,30 kg

code:



red / gold
FILIGRANA40RG



white / gold
FILIGRANA40WG



gold leaf / white
FILIGRANA40FOW



black / silver
FILIGRANA40BS



silver leaf / black
FILIGRANA40FAB



Filigrana 44

Florence Glass
ATELIER

brevettato / patented

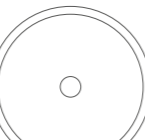

Ø 440

h 150



Ø foro / hole = 45 mm
peso / weight = 5,20 kg

code:



red / gold
FILIGRANA44RG



white / gold
FILIGRANA44WG



gold leaf / white
FILIGRANA44FOW



black / silver
FILIGRANA44BS



silver leaf / black
FILIGRANA44FAB





Flare tech 40

Florence Glass
ATELIER

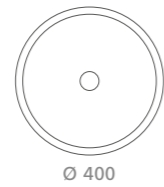

Ø 400

h 150



brevettato / patented

Ø foro / hole = 45 mm
peso / weight = 4,30 kg

code:



white / gold leaf
FLARET40WG



black / silver leaf
FLARET40BS



Flare tech 44

Florence Glass
ATELIER

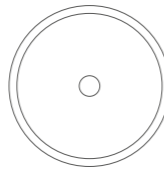

Ø 440

h 150



brevettato / patented

Ø foro / hole = 45 mm
peso / weight = 5,20 kg

code:



white / gold leaf
FLARET44WG



black / silver leaf
FLARET44BS



Flare 34

Florence Glass
ATELIER

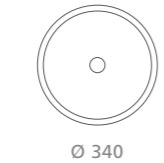

Ø 340

h 125

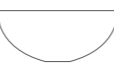

brevettato / patented

Ø foro / hole = 45 mm
peso / weight = 3,10 kg

code:



mat
FLARE34S01



white / gold
FLARE34WG



black / silver
FLARE34BS



Flare 40

Florence Glass
ATELIER

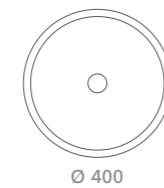

Ø 400

h 150



brevettato / patented

Ø foro / hole = 45 mm
peso / weight = 4,30 kg

code:



mat
FLARE40S01



white / gold
FLARE40WG



black / silver
FLARE40BS



Flare 44

Florence Glass
ATELIER

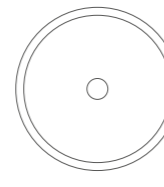

Ø 440

h 150



brevettato / patented

Ø foro / hole = 45 mm
peso / weight = 5,20 kg

code:



mat
FLARE44S01



white / gold
FLARE44WG



black / silver
FLARE44BS



Xeni

Florence Glass
ATELIER

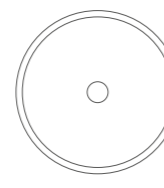

Ø 440

h 220

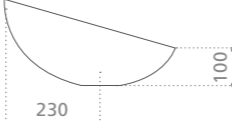

brevettato / patented

Ø foro / hole = 45 mm
peso / weight = 5,20 kg

code:



white
XENIT01WHITE



black
XENIT30BLACK



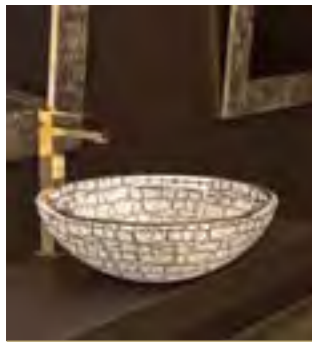

Kalahari
34
Florence Glass
ATELIER



Ø foro / hole = 45 mm
peso / weight = 3,10 kg

code:



white / gold
KALAHARI34WG



black / silver
KALAHARI34BS



Kalahari
40
Florence Glass
ATELIER

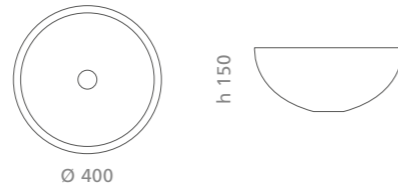

Ø foro / hole = 45 mm
peso / weight = 4,30 kg

code:



white / gold
KALAHARI40WG



black / silver
KALAHARI40BS



Kalahari
44
Florence Glass
ATELIER

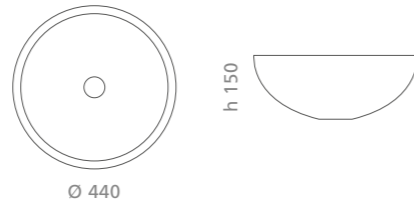

Ø foro / hole = 45 mm
peso / weight = 5,20 kg

code:



white / gold
KALAHARI44WG



black / silver
KALAHARI44BS



Flou
Florence Glass
ATELIER

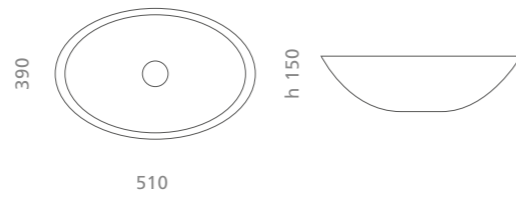

Ø foro / hole = 45 mm
peso / weight = 6,50 kg

code:



clear
FLOUT01



black / gold
FLOUBG



black / silver
FLOUBS



white/gold
FLOUWG



gold leaf
FLOUFO



silver leaf
FLOUFA



Soffio
Florence Glass
ATELIER

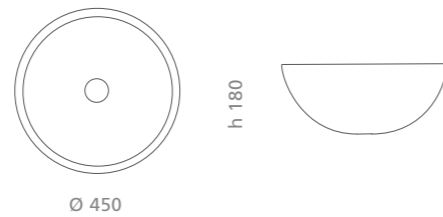

Ø foro / hole = 45 mm
peso / weight = 6,00 kg

code:



clear
SOFFIOT01



black / gold
SOFFIOBG



black / silver
SOFFIOBS



white/gold
SOFFIOWG



gold leaf
SOFFIOFO



silver leaf
SOFFIOFA



Tekno Materic 40

Florence Glass
ATELIER

brevettato / patented

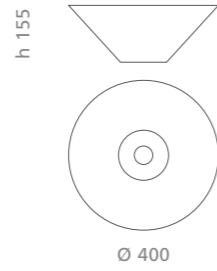

Ø foro / hole = 45 mm
peso / weight = 3,40 kg

code:



clear
TEKNO40T01



white mat
TEKNO40BO



black mat
TEKNO40NO



beige mat
TEKNO40BGO



Tekno Metal 40

Florence Glass
ATELIER

brevettato / patented

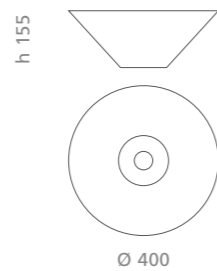

Ø foro / hole = 45 mm
peso / weight = 3,40 kg

code:



iron
TEKNO40IR



platinum
TEKNO40PL



copper
TEKNO40CP



bronze
TEKNO40BZ

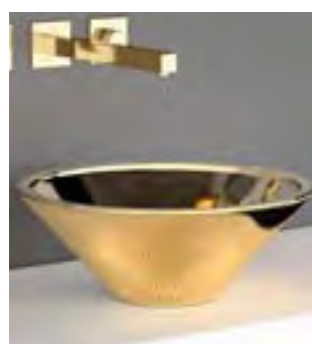

Tekno Lux 40

Florence Glass
ATELIER

brevettato / patented

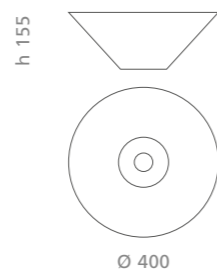

Ø foro / hole = 45 mm
peso / weight = 3,40 kg

code:



silver
TEKNO40LSL



platinum
TEKNO40LPL



gold pink
TEKNO40LPG



gold
TEKNO40LGD



Filò Katino

Florence Glass
ATELIER

brevettato / patented

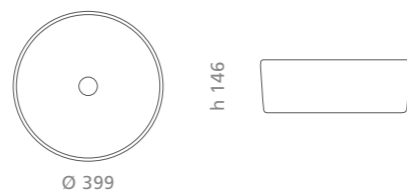

Ø foro / hole = 45 mm
peso / weight = 3,40 kg

code:



grey filò
FILOK39GR



amber filò
FILOK39AM



Bamboo Katino

Florence Glass
ATELIER

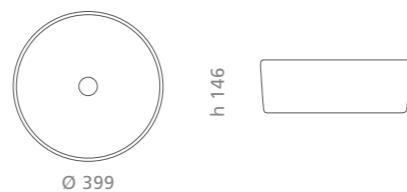

Ø foro / hole = 45 mm
peso / weight = 3,40 kg

code:



white
BAMBOOK39BO



black
BAMBOOK39NO



grey
BAMBOOK39GR



copper
BAMBOOK39CP



silver glitter
BAMBOOK39SLH



gold glitter
BAMBOOK39GDH



Oasy 40

Florence Glass
ATELIER



Ø foro / hole = 45 mm
peso / weight = 4,30 kg

code:



white
OASY40BO



black
OASY40NO



grey
OASY40GR



copper
OASY40CP



white/gold
OASY40WG



black/silver
OASY40BS



Perla 30

Florence Glass
ATELIER

brevettato / patented

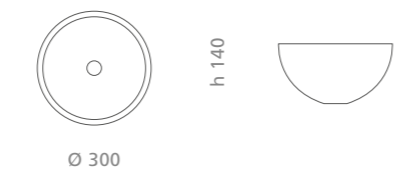

Ø foro / hole = 45 mm
peso / weight = 2,68 kg

code:



white/silver leaf
PERLA30BFA



white/gold leaf
PERLA30BFO



beige/silver leaf
PERLA30BGFA



beige/gold leaf
PERLA30BGFO



black/silver leaf
PERLA30NFA



black/gold leaf
PERLA30NFO



Perla 40

Florence Glass
ATELIER

brevettato / patented

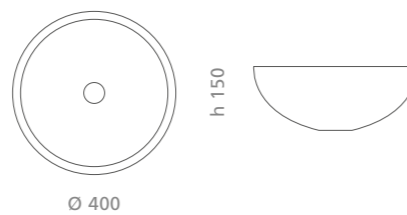

Ø foro / hole = 45 mm
peso / weight = 4,30 kg

code:



white/silver leaf
PERLA40BFA



white/gold leaf
PERLA40BFO



beige/silver leaf
PERLA40BGFA



beige/gold leaf
PERLA40BGFO



black/silver leaf
PERLA40NFA



black/gold leaf
PERLA40NFO



I colori rappresentati in stampa si intendono puramente indicativi. - Print colors of the wash basins may vary slightly from original color.



Onda 30

Florence Glass
ATELIER

brevettato / patented

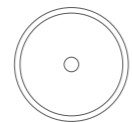

Ø 300

h 140



Ø foro / hole = 45 mm
peso / weight = 2,68 kg

code:



white/silver leaf
ONDA30BFA



white/gold leaf
ONDA30BFO



beige/silver leaf
ONDA30BGFA



beige/gold leaf
ONDA30BGFO



black/silver leaf
ONDA30NFA



black/gold leaf
ONDA30NFO



Globo

Florence Glass
ATELIER

brevettato / patented



Ø 340

h 156



Ø foro / hole = 45 mm
peso / weight = 3,65 kg

code:



clear
GLOBO34T01



white mat
GLOBO34BO



black mat
GLOBO34NO



beige mat
GLOBO34BGO



Loop 40

Florence Glass
ATELIER



Ø 400

h 150



Ø foro / hole = 45 mm
peso / weight = 4,30 kg

code:



pale gold
LOOP40GDP



iron
LOOP40IR



copper
LOOP40CP



bronze
LOOP40BZ



red metal
LOOP40RD

Loop 44

Florence Glass
ATELIER

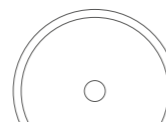

Ø 440

h 150



Ø foro / hole = 45 mm
peso / weight = 5,20 kg

code:



pale gold
LOOP44GDP

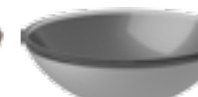

iron
LOOP44IR



copper
LOOP44CP



bronze
LOOP44BZ



red metal
LOOP44RD

INOX ZERO®

“Inox 3D” “Inox 3D”

L'evoluzione dell'inox.
Inox evolution.



Mito
INOX ZERO®

brevettato / patented

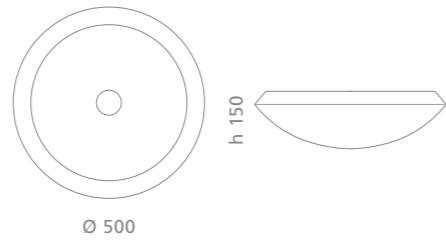

Ø foro / hole = 45 mm
peso / weight = 2,17 kg

code:



shiny inox
MITOIL01



bruno starlight
MITOLH33



cobalto
MITOCB

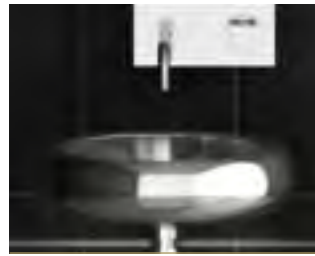

Glo Ball
INOX ZERO®

brevettato / patented

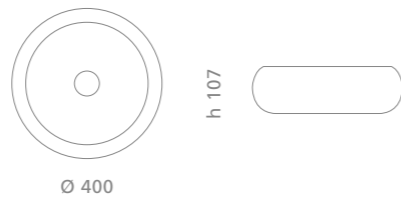

Ø foro / hole = 45 mm
peso / weight = 1,90 kg

code:



shiny inox
GLOBALLI01



bruno starlight
GLOBALLH33



rame starlight
GLOBALLH36



carminio
GLOBALLCR



cobalto
GLOBALLCB



De Coste
INOX ZERO®

brevettato / patented

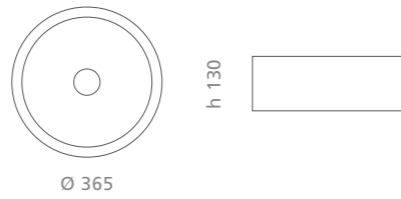

Ø foro / hole = 45 mm
peso / weight = 1,90 kg

code:



brushed inox
DECOSTEIS01



bruno starlight
DECOSTELH33



rame starlight
DECOSTELH36



carminio
DECOSTECR



cobalto
DECOSTECB

Siliconio®

“Touch design per eccellenza” “Excellence you can touch and feel”

Il design tattile, morbido, elastico, sensuale.
Touch and feel - soft and sensual.



Barchetta
Siliconio®

brevettato / patented

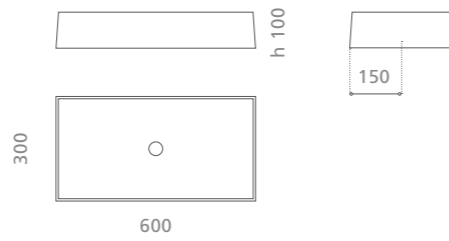

Ø foro / hole = 45 mm
peso / weight = 5,50 kg

code:



green
BARCHSL32



black
BARCHSL30



red
BARCHSL34



blue
BARCHSL02



Barchetta light
Siliconio®

brevettato / patented

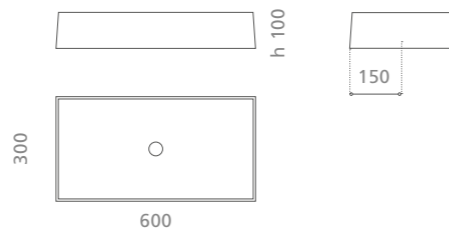

Ø foro / hole = 45 mm
peso / weight = 5,70 kg

code:



red light
BARCHSL34L



blue light
BARCHSL02L

completo di illuminazione led e trasformatore.
Led light and transformer included.



Gum
Siliconio®

brevettato / patented

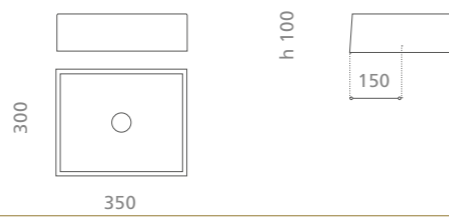

Ø foro / hole = 45 mm
peso / weight = 3,20 kg

code:



white
GUMSL01



yellow
GUMSL05



orange
GUMSL26



red
GUMSL34



blue
GUMSL02

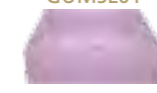

plum
GUMSL82

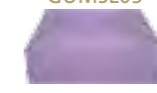

violet
GUMSL87



alice blue
GUMSL43



black
GUMSL30

Dettagli di “valore”

Base anello

Base ring

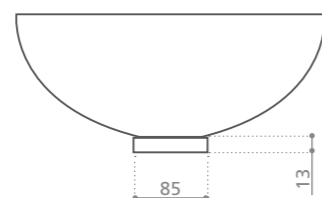

oro / gold
ANF3

cromo / chrome
ANF4

Troppo pieno

Troppo pieno completo per scarico lavabo 1" 1/4
Overflow joint for basin waste 1" 1/4

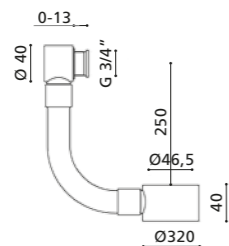

cromo / chrome
TP



oro / gold
TPG

Troppo pieno ABS

Troppo pieno per lavabi sottopiano ABS bianco (con anello cromato)
White ABS basin overflow (with chromed ring) for under mounted wash basins



cromo / chrome
TPA

Tondo

Sifone tondo
Round siphon

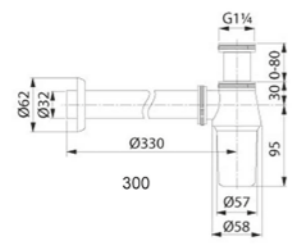

cromo / chrome
SIFHF4



oro / gold
SIFHF3

Quadro

Sifone quadrato
Square siphon

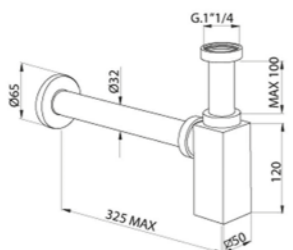

cromo / chrome
SIFQ4



oro / gold
SIFQ3

Piletta scarico libero

Piletta a scarico libero con logo GD
Waste with free flow plug with GD logo
(Ø 70 - H 100 mm)

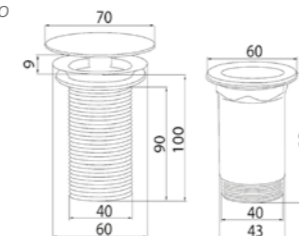

cromo
chrome
SCCR



nero opaco
black mat finish
SCBL



oro
gold finish
SCGD

Piletta ABS scarico libero

Piletta ABS a scarico libero con logo GD
ABS waste with free flow plug with GD logo
(Ø 72 - H 90 mm)

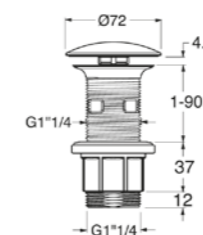

ABS cromo
ABS chrome
SCCR 100

Piletta klik-clak

Piletta klik clak con logo GD (senza troppo pieno)
Up & Down waste with GD logo (without overflow)
(Ø 63,5 - H 100 mm)



cromo
chrome
SCCRP



nero opaco
black mat finish
SCBLP



oro
gold finish
SCGDP

Piletta ABS klik-clak

Piletta ABS klik clak con logo GD utilizzabile per lavabi senza e con troppo pieno
Up & Down ABS waste with GD logo suitable for washbasins with and without overflow
(Ø 72 - H 90 mm)

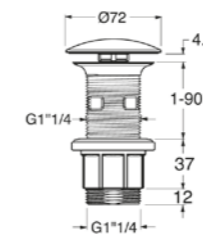

ABS cromo
ABS chrome
SCCRP 100

Piletta klik-clak

Piletta klik clak con logo GD (con troppo pieno)
Up & Down waste with GD logo (with overflow)
(Ø 63,5 - H 100 mm)

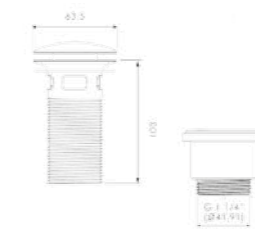

cromo
chrome
SCCRTP



nero opaco
black mat finish
SCBLTP

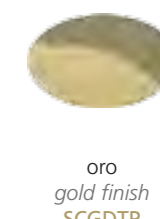

oro
gold finish
SCGDTP

Piletta scarico libero tappo XL

Piletta a scarico libero con logo GD
Waste with free flow plug with GD logo
(Ø 105 - H 100 mm)

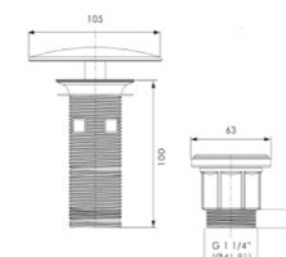

ABS cromo
ABS chrome
SCCR XL

“Accessori”

Accessories

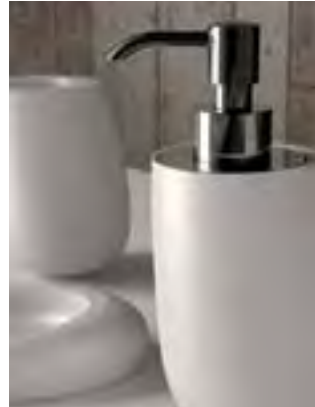

Kleiss
Vetro Freddo

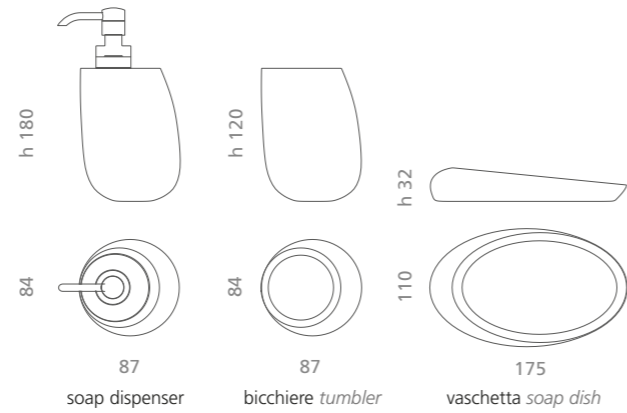

code: *white*
KLSETPO01



code: *black*
KLSETPO30



code: *moka*
KLSETPO33



code: *cognac*
KLSETTO35



Navy
Vetro Freddo

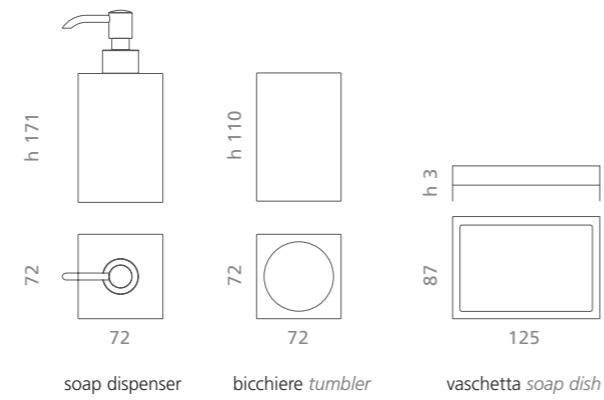

code: *white*
NVSETPO01



code: *black*
NVSETPO30



code: *moka*
NVSETPO33



code: *cognac*
NVSETTO35



Glamour
Alumix

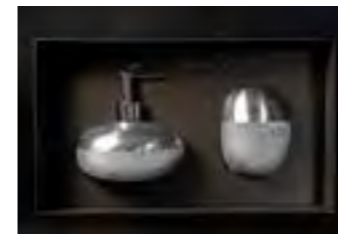
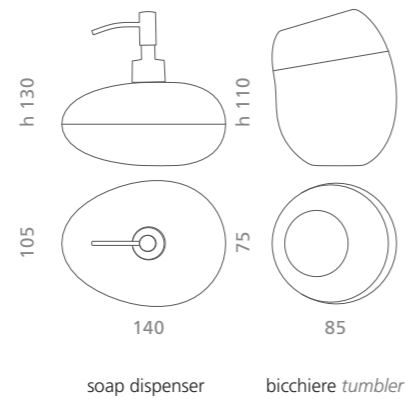

code: *white / silver*
GLAMSETA05

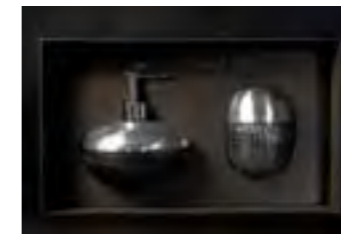

code: *black / silver*
GLAMSETA02

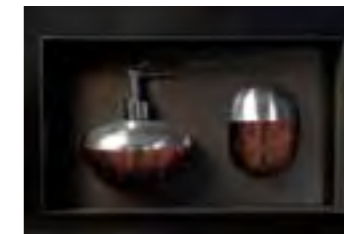

code: *brown / black*
GLAMSETA03



Luxury
Glass

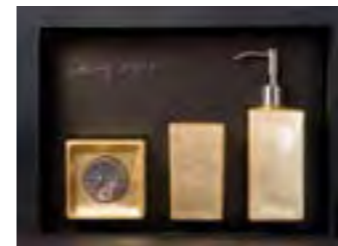
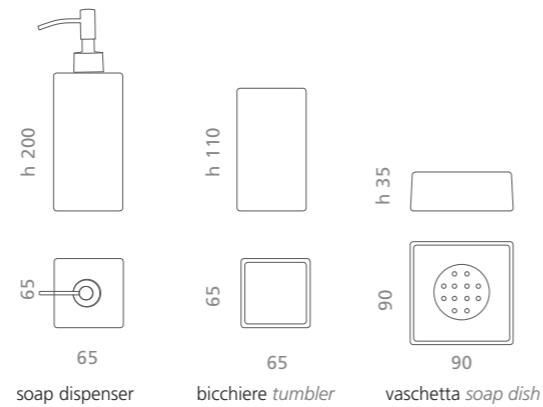

code: *gold leaf 3d*
LUXSETFO

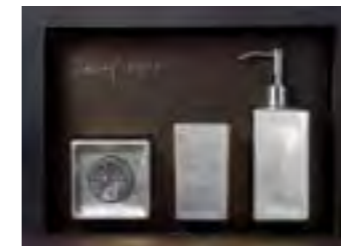

code: *silver leaf 3d*
LUXSETFA



Golf

Vetro Freddo



h 215
85
soap dispenser

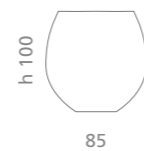

h 100
85
bicchiere / tumbler



h 25
142x 110
vaschetta / soap dish



code: *white*
GOLFSETPO01



code: *cognac*
GOLFSETTO35



code: *fumè*
GOLFSETTO43



Frozen

Vetro Freddo

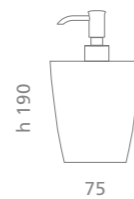

h 190
75
soap dispenser

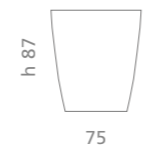

h 87
75
bicchiere / tumbler



h 26
150 x 110
vaschetta / soap dish



code: *white*
FROZSETPO01



code: *cognac*
FROZSETTO35



code: *fumè*
FROZSETTO43



Kalahari

Glass

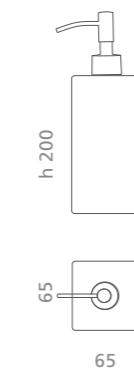

h 200
65
soap dispenser

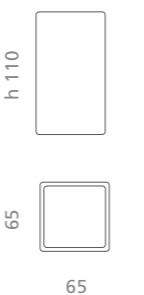

h 110
65
bicchiere tumbler

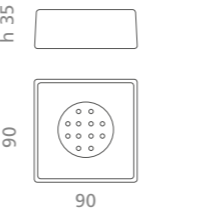

h 35
90
vaschetta soap dish



code: *white / gold*
KALSETWG



code: *black / silver*
KALSETBS



Venice

Glass

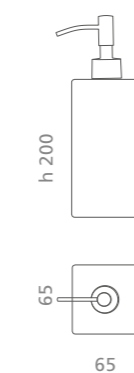

h 200
65
soap dispenser

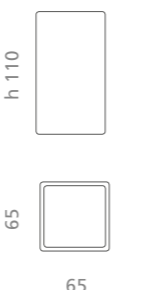

h 110
65
bicchiere tumbler

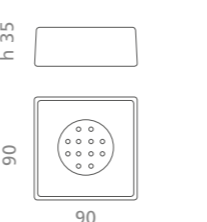

h 35
90
vaschetta soap dish



code: *gold / silver*
VENSETOA



code: *black / silver*
VENSETAN



code: *brown / ivory*
VENSETMA



Graffiti

Glass

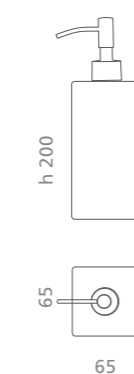

h 200
65
soap dispenser

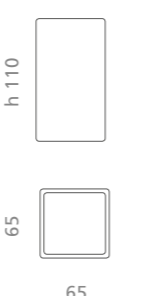

h 110
65
bicchiere tumbler

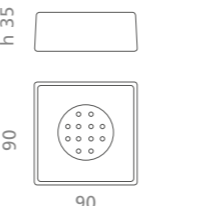

h 35
90
vaschetta soap dish



code: *black / silver*
GRAFSETBS



code: *red / gold*
GRAFSETRO



Icessence n°1
Soap dispenser

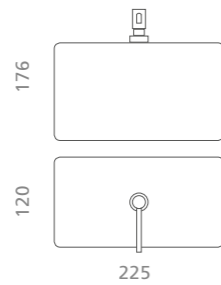

clear / chrome
ICESSENCE1T01F4



clear / gold
ICESSENCE1T01F3

Icessence n°2
Perfume diffuser

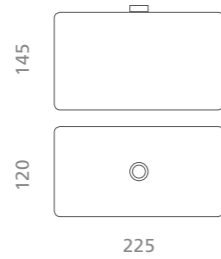

clear / chrome
ICESSENCE2T01F4



clear / gold
ICESSENCE2T01F3



Icessence Luxor n°1
Soap dispenser

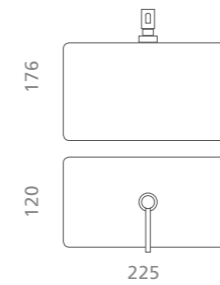

clear / chrome
ICESSENCELUX1T01F4



clear / gold
ICESSENCELUX1T01F3

Icessence Luxor n°2
Perfume diffuser

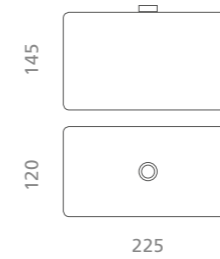

clear / chrome
ICESSENCELUX2T01F4

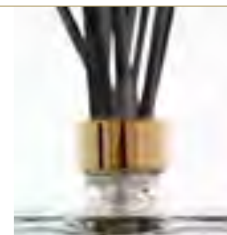

clear / gold
ICESSENCELUX2T01F3



Icessence Ice n°1
Soap dispenser

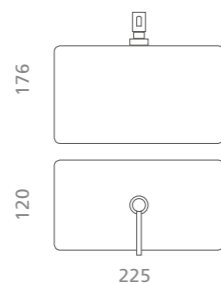

clear / chrome
ICESSENCEICE1T01F4



clear / gold
ICESSENCEICE1T01F3

Icessence Ice n°2
Perfume diffuser

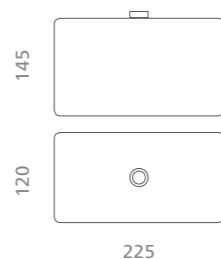

clear / chrome
ICESSENCEICE2T01F4

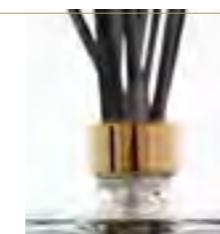

clear / gold
ICESSENCEICE2T01F3



Icessence Ramada n°1
Soap dispenser

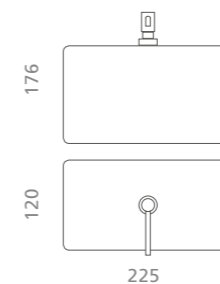

clear / chrome
ICESSENCERAM1T01F4



clear / gold
ICESSENCERAM1T01F3

Icessence Ramada n°2
Perfume diffuser

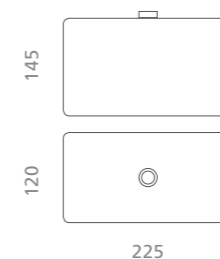

clear / chrome
ICESSENCERAM2T01F4

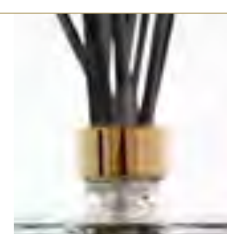

clear / gold
ICESSENCERAM2T01F3



SPECIAL ONE

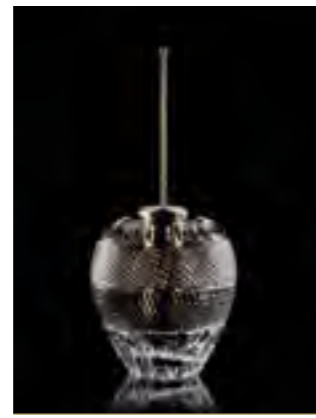

Opera
large

Cristallo
DE' MEDICI
Pd 24%

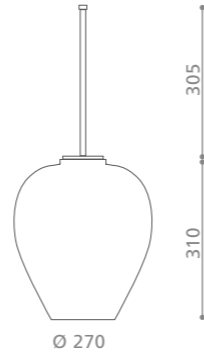

code:



clear / gold
OPERALT01F3



clear / chrome
OPERALT01F4



Opera
xl

Cristallo
DE' MEDICI
Pd 24%

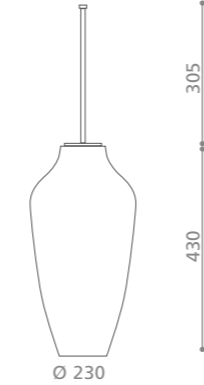

code:



clear / gold
OPERAXLT01F3



clear / chrome
OPERAXLT01F4

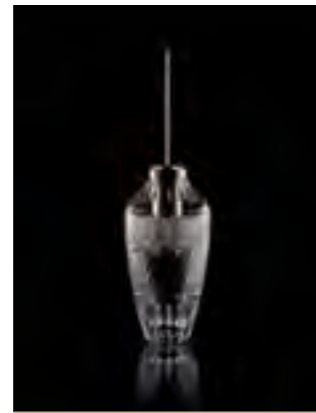

Opera
small

Cristallo
DE' MEDICI
Pd 24%

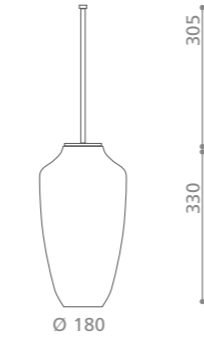

code:



clear / gold
OPERAST01F3



clear / chrome
OPERAST01F4



Canto
xl

Cristallo
DE' MEDICI
Pd 24%

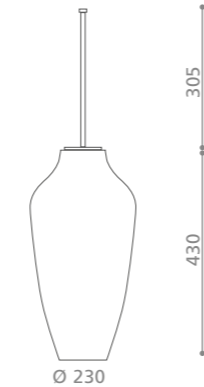

code:



clear / gold
CANTOXLT01F3



clear / chrome
CANTOXLT01F4



Canto
small

Cristallo
DE' MEDICI
Pd 24%

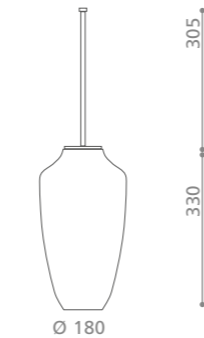

code:



clear / gold
CANTOST01F3



clear / chrome
CANTOST01F4



Luxury toilet brush

“Materiali”

Materials

Design senza confini

Design without borders

Vetro Freddo®

Il Vetro Freddo® è un materiale innovativo, composto da pigmenti vetrosi e resine. La sua caratteristica principale è la sua versatilità nell'adattarsi a qualsiasi tipo di forma. E' l'esaltazione della materia che si esprime attraverso l'anima del suo colore. La natura della sua materia, composta da pigmenti vetrosi e pertanto trasparenti, permette al VetroFreddo® di avere uno dei suoi principali punti di forza, e cioè la possibilità di esprimersi in colori trasparenti, traslucidi od opachi. Nessun limite quindi a livello cromatico e, oltre alla gamma di colori già esistente, è possibile scegliere in base alle proprie esigenze, uno dei numerosi colori presenti nella mazzetta "RAL". Il VetroFreddo® ha una resistenza termica di circa 100°C e può essere lavorato con gli stessi utensili del marmo o del vetro. Tutti gli oggetti in VetroFreddo® si possono lavare con qualsiasi tipo di sapone o detergente neutro non granulare, usando panni o spugne non abrasive. In caso di graffi superficiali, si può ripristinare l'oggetto intervenendo con un panno imbevuto di olio d'oliva o una semplice crema per le mani. In caso di graffi più profondi, è possibile ripristinare con una speciale carta vetro suggerita dal produttore in base al colore o al tipo di oggetto.

VetroFreddo® is an innovative material composed of glass pigments and resin. Its major characteristics are its versatility in adapting itself to any form or shape imaginable. The material's unique characteristics are expressed through the soul of its colour, which can be in transparent, semi-transparent or opaque form, due to the material composition of glass pigments. No limits exist in regards to colour. Apart from the existing range of colours, any colour from the "RAL" colour scheme can be chosen. VetroFreddo® is temperature resistant up to approximately 100°C and can be worked with and carved just as marble or glass. All objects designed with the material VetroFreddo® can be cleaned with any type of non-granular soap, using soft sponges or tissues.

In case of superficial damage (scratches), the damaged area should gently be rubbed with a sheet soaked in olive oil.

In case of deeper scratches or damage, a special replacement glass paper is available from the manufacturer for every colour and type of object.



Pert®

polimero tecnologico

Il Pert® è un polimero tecnologico dalle qualità eccezionali, che unisce un basso peso specifico ad un'elevata resistenza meccanica. Particolarmente adatto in quei settori dove l'esigenza della leggerezza del peso è fondamentale (nautico, aereo, camper...). E' un materiale che permette la realizzazione di prodotti di elevato design, eseguiti a regola d'arte, rispettando angoli, raggi, bassorilievi e planarità con la possibilità di scelta tra una vasta gamma di colori, personalizzabili a richiesta. Pert® is a technological polymer of extraordinary quality, combining a low specific weight with high mechanical resistance. It is particularly suited to fields where light weight is essential (e.g. in nautical, aeronautical, camping, ...).

It is a material which enables the creation of products of high design, finely made, allowing perfectly crafted angles and a smoothly plane surface, with the possibility of choosing among a wide range of colours to suit individual demand.



TeknoForm®

TeknoForm® è il materiale delle "texture", costituito da polimeri di varia natura, si esprime dando vita a prodotti monoscocca, esaltando le sue superfici. Dai mosaici alle pietre, dai marmi ai legni, tante soluzioni che danno vita a prodotti unici.

TeknoForm® is a polymer-based material. It expresses itself by enhancing the surface of its products.

From mosaics to stone, from marble to wood, an incredible variety of solutions can be realized in creating unique products.



Alumix®

Prodotto hi-tech, elegante e contemporaneo che nasce da una fusione di lega di alluminio. La decorazione è realizzata a pennello, con la tecnica del graffiato, per ottenere un effetto bicromatico. Il bordo è spazzolato e lucidato a mano, per valorizzare l'anima ed il colore tipico di questo materiale.

A high-tech product, both elegant and contemporary, born from a merger of aluminum alloys. The decorations are brush-painted, employing a special brush technique in order to obtain a bi-chromatic effect. The board is brushed and polished by hand to enhance the soul and color, which are typical for this material.



made with MURANO® glass

Il vetro di Murano è da sempre sinonimo di raffinatezza, leggerezza ed eleganza. I maestri vetrai hanno saputo sviluppare tecniche di lavorazioni privilegiate, nel rispetto della millenaria tradizione che rende il vetro di Murano un prodotto unico, prestigioso e inimitabile.

Murano glass is a synonym for elegance and timelessness.

By combining innovative techniques with traditional artisan workmanship, unique, prestigious and inimitable objects are created.

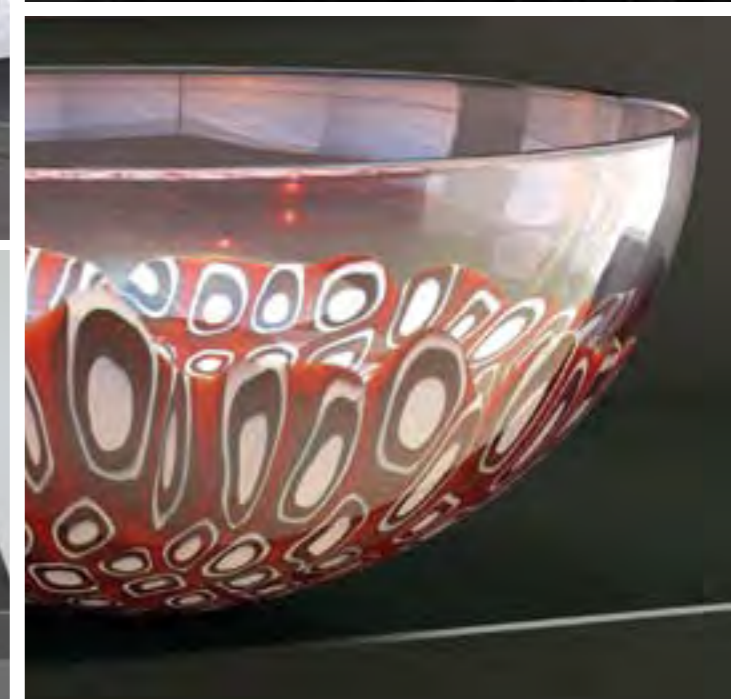
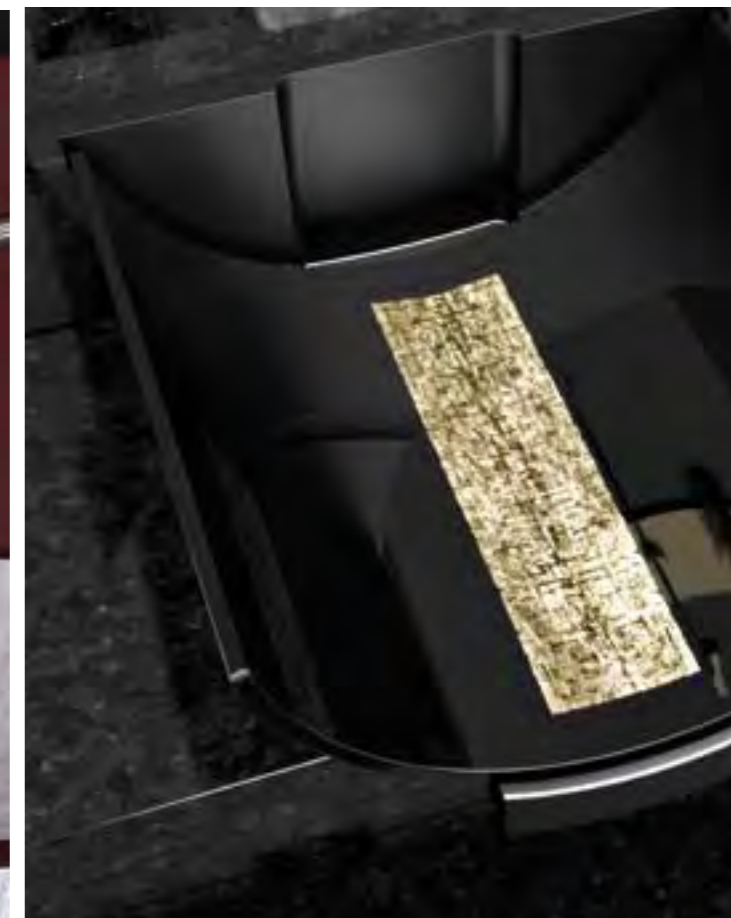

Collezioni esclusive, realizzate in cristallo purissimo al 24% pb. Si tratta di prodotti raffinatissimi, soffiati a bocca e molati a pietra con abilità, dai nostri maestri secondo le più antiche e nobili arti vetrarie. Nessuna macchina, nessuna tecnologia, ma solo prodotti d'arte, classici, contemporanei ... futuristici. Exclusive collections created from pure crystal with 24% lead content. These utmost refined products are mouth-blown and bevelled in stone by our master artists according to the most ancient and noble glass arts. Neither machines nor technology are employed in the process, resulting in classical, contemporary or futuristic art products.

Il progetto Atelier nasce dalla ricerca stilistica che una nostra equipe interna realizza rivolgendo lo sguardo al mondo della moda. I colori e le texture che vengono rappresentati nel programma sono la sintesi delle nuove tendenze. The "Florence Glass Atelier" project is inspired by embedding the philosophy of the fashion world into product research. The focus lays on enhancing crystal material with colours and textures of fashion trends.

Nuova tecnologia applicata per dar vita ad un prodotto inox (18/8) tridimensionale. Peso specifico ridottissimo nonostante i volumi. Varie sono le espressioni cromatiche dal colore tipico dell'inox lucido, spazzolato fino all'ultima generazione di colori high-tech. The products of the INOX ZERO Collection are made out of stainless steel (18/8), utilising advanced production processes enabling the combination of expressive design with of low weight. A wide range of colours can be achieved, from timeless metallic shades to prestigious brushed and avant-garde colours.

Siliconio®, ultima generazione della famiglia dei siliconi. Via al design all'insegna dell'elasticità, dalle forme più rigorose che sfruttano le grandi potenzialità di questa materia, a quelle più bizzarre e originali. E' un materiale dalle forti sensazioni tattili: morbido, elastico, sensuale, unico. Siliconio®, quale materiale elastico, può essere sottoposto a torsioni, allungamenti e piegamenti ed in corso di rilascio torna alla sua forma originale. Siliconio® è idrorepellente, antinfortunistico, resistente a temperature tra - 60°C e + 250°C, lavabile, autoestinguente, atossico, dotato di resistenza chimica eccellente. Siliconio® è Touch design per eccellenza. Siliconio®, is the latest development in the family of silicone materials. Featuring unique designs based on its elasticity, it allows for rigorous shapes, benefiting from the great potential of the material, being amongst the most unique and original. It is a material of touch: soft, elastic, sensual - simply unique. Siliconio® can be bent and folded in any possible way, always returning to its original form once released. Siliconio®, is water-repellent and, soft, thus reducing the risk of injury, but also resistant to extreme temperatures from -60°C to +250°C, washable, self-extinguishing, non-toxic and with excellent chemical resistance characteristics. Siliconio® is 'Touch design' at its very best.

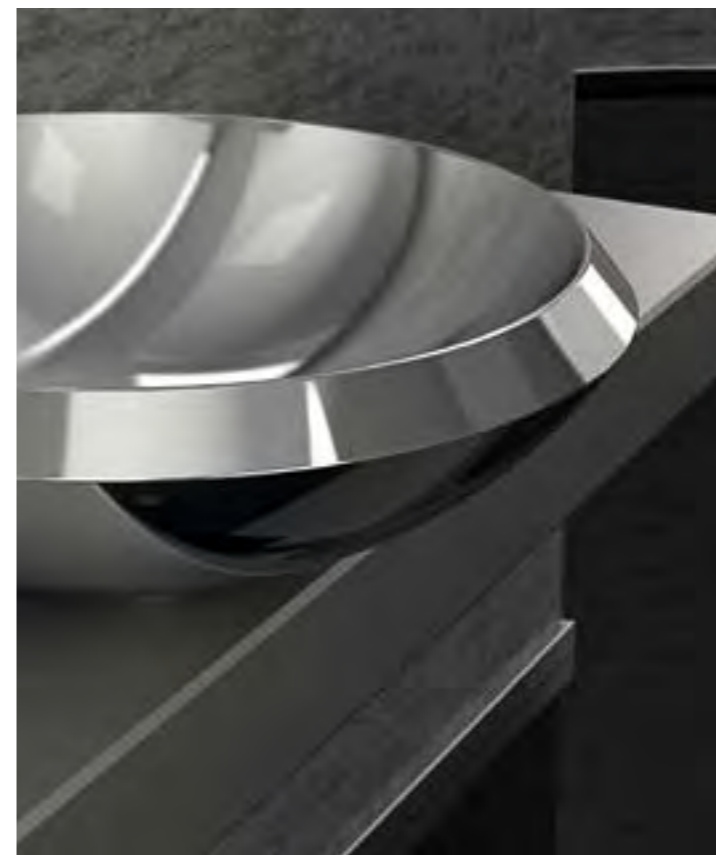



CERTIFICAZIONI
CERTIFICATIONS



GLASS DESIGN S.R.L.
Via Limitese, 122/124 - 50053 Vinci (Firenze) ITALY
Tel. +39 0571 902311 / +39 0571 902501
Fax +39 0571 902312
glassdesign@glassdesign.it | www.glassdesign.it

Copyright © Glass Design srl. Tutti i diritti riservati - All rights reserved.

Graphic and visual design:
info@giacomomasoni.com

stampato su carta certificata FSC®



Il marchio FSC identifica i prodotti derivanti dal legno, provenienti da foreste gestite in maniera responsabile secondo rigorosi standard ambientali, sociali ed economici.



    
DESIGN ITALY GLASS DESIGN ITALY GLASS DESIGN ITALY GLASS DESIGN ITALY GLASS

    
DESIGN ITALY GLASS DESIGN ITALY GLASS DESIGN ITALY GLASS DESIGN ITALY GLASS

    
DESIGN ITALY GLASS DESIGN ITALY GLASS DESIGN ITALY GLASS DESIGN ITALY GLASS

    
DESIGN ITALY GLASS DESIGN ITALY GLASS DESIGN ITALY GLASS DESIGN ITALY GLASS

    
DESIGN ITALY GLASS DESIGN ITALY GLASS DESIGN ITALY GLASS DESIGN ITALY GLASS

    
DESIGN ITALY GLASS DESIGN ITALY GLASS DESIGN ITALY GLASS DESIGN ITALY GLASS

GLASS DESIGN s.r.l. - Via Limitese 122/124 - 50053 Vinci (Firenze) Italy
tel. +39 0571 902311 / 902501 - Fax +39 0571 902312
glassdesign@glassdesign.it - www.glassdesign.it

    
DESIGN ITALY GLASS DESIGN ITALY GLASS DESIGN ITALY GLASS DESIGN ITALY GLASS